

**Espino Tract, 16-inch Offsite Water Line (Oversized)
Stormwater Pollution Prevention Plan
For large
construction activities**

Developed For

KB Home Lone Star, Inc.
4800 Fredericksburg Rd, San Antonio, TX 78229

May 7, 2025

Developed By

Compliance Resources, Inc.
P.O. Box 2628
Georgetown, Texas 78627
512.930.7733
www.complianceresourcesinc.com



Amber J. Scheler

TABLE OF CONTENTS

1. Introduction

- Regulatory Requirements for Construction Stormwater
- Site Size
- Notice of Intent
- SWPPP and Permit Amendment
- Notice of Termination
- Transfer of Day-to-Day Operational Control
- Signage Requirements
- Edwards Aquifer Requirements
- Tribal, Local, and State Requirements
- Retention of Records

2. Site Description

- Site Description
- Soil Types
- 100-Year Floodplain
- Receiving Waters and Description of Drainage System
- Impaired Water Body
- Total Maximum Daily Load (TMDL)
- Critical Environmental Features
- Endangered or Threatened Species

3. Site Scope, SWPPP Responsibility, and Construction Activity Logs

- Site Scope
- SWPPP Responsibility
- Construction Activity Logs

4. Maps

- Master Plan Map
- Local Map
- Topographic Map
- Property Boundary Map
- Demolition Plan (if applicable)
- Erosion and Sediment Control Plan
- Proposed Stabilization Map
- BMP Tracking Map

5. Best Management Practices

- Erosion and Sediment Control Requirements Applicable to All Sites
- Concrete Truck Wash Out Requirements
- Potential Pollutant Sources
- Non-Stormwater Discharges
- BMP Responsibility and Implementation
- BMP Specifications

6. Dewatering

- Dewatering Details
- Dewatering Evaluation

7. Spill Prevention and Response

- Spill Response Protocol

8. Inspection Requirements

- Inspection Frequency
- Inspection Report Requirements
- Inspection and Entry

Qualified Personnel
SWPPP Writer Qualifications
Inspector Qualifications
Sample Inspection Form

9. Regulatory Correspondence

Regulatory Inspections

10. Amendments

Appendix A – SWPPP Signed Documents

Construction Site Notice (CSN)
Permit Certificate, NOI, NOC, NOT and MS4 notifications
Delegation Letter for Signatories to Reports
SWPPP Certification
Edwards Aquifer Regional Office notification (if applicable)

Appendix B – Edwards Aquifer Protection Plan

Appendix C – Inspection Reports

Appendix D – Site Maps

Appendix E – Dewatering Evaluations

Appendix F - Transfer of Day-to-Day Operational Control

Storm Water Pollution Prevention Plan
For Espino Tract, 16-inch Offsite Water Line (Oversized)

1. Introduction

Regulatory Requirements for Construction Stormwater

Section 26.040 of the Texas Water Code and Section 402 of the Clean Water Act require that at least one stormwater pollution prevention plan (SWPPP) shall be developed for each construction project or site covered by the permit.

The SWPPP shall be completed prior to a submittal of the Notice of Intent and shall provide for compliance with the terms and schedule of the SWPPP beginning with the initiation of construction activities.

The SWPPP shall be available, upon request, to the Director, a State, Tribal, or local agency approving sediment and erosion control plans, grading plans, or stormwater management plans; local government officials; or the operator of a municipal separate storm sewer system receiving discharges from the site.

Site Size

Small construction activities are construction activities disturbing at least 1 acre, but less than 5 acres and are not part of a larger common plan of development or sale that cumulatively disturbs 5 or more acres.

Large construction activities are construction activities disturbing 5 or more acres, or less than 5 acres if part of a larger common plan of development or sale that cumulatively disturbs five or more acres.

Notice of Intent

The NOI must be submitted to TCEQ through the State of Texas Environmental Electronic Reporting System (STEERS) prior to the start of construction (an email confirmation receipt must be received from TCEQ before starting construction). The NOI must be signed by a duly authorized representative and retained on site where the stormwater discharge is generated. All authorization numbers will be posted onsite.

A copy of the 'signed and certified' Notice(s) of Intent (NOI) must be supplied to the operator of the Municipal Separate Storm Sewer System (MS4) if discharges enter an MS4 at least two (2) days prior to commencement of construction activities.

This site discharges to the following MS4(s): Bexar County, San Antonio Water System (SAWS)

Applications and notifications are located in Appendix A.

Storm Water Pollution Prevention Plan
For Espino Tract, 16-inch Offsite Water Line (Oversized)

Operator Name	Operator Scope	Operator Type
KB Home Lone Star, Inc.	Developer/Owner	Primary
GENERAL CONTRACTOR TO BE DETERMINED	General Contractor	Primary

Storm Water Pollution Prevention Plan
For Espino Tract, 16-inch Offsite Water Line (Oversized)

SWPPP and Permit Amendment

The permittee must revise or update the SWP3, including the site map, within seven (7) days of when any of the following occurs:

- a change in design, construction, operation, or maintenance that has a significant effect on the discharge of pollutants and that has not been previously addressed in the SWP3;
- changing site conditions based on updated plans and specifications, new operators, new areas of responsibility, and changes in BMPs; or
- results of inspections or investigations by construction site personnel authorized by the permittee, operators of a municipal separate storm sewer system receiving the discharge, authorized TCEQ personnel, or a federal, state or local agency approving sediment and erosion plans indicate the SWP3 is proving ineffective in eliminating or significantly minimizing pollutants in discharges authorized under this general permit.

Permittees must submit a Notice of Change (NOC) to TCEQ through the State of Texas Environmental Electronic Reporting System (STEERS) within 14 days to the executive director upon the discovery of a change in information or an omission, inaccuracies or submittal of incorrect information on the Notice of Intent. A copy of the Notice of Change must also be submitted to the operator of the MS4 receiving the discharge from the site.

Changes to Authorization Log

Operator Name	Authorization Number	Operator Scope	Summary of Changes
KB Home Lone Star, Inc.	TXR1503UU	Owner/Developer	-Changing acreage from 31.2 acres to 29.28 acres

This site discharges to the following MS4(s): Bexar County, San Antonio Water System (SAWS)

Applications and notifications are located in Appendix A.

Storm Water Pollution Prevention Plan
For Espino Tract, 16-inch Offsite Water Line (Oversized)

Notice of Termination

Permittees must submit a completed Notice of Termination (NOT) to TCEQ through the State of Texas Environmental Electronic Reporting System (STEERS) (must be signed by a duly authorized representative) upon meeting any of the following conditions:

- Final stabilization has been achieved on all portions of the site that are the responsibility of the operator (a uniform perennial vegetative cover with a density of 70% of the native background vegetative cover for the area on all unpaved areas and areas not covered by permanent structures, or equivalent permanent stabilization measures have been employed)
- A transfer of operational control has occurred
- The operator has obtained alternative authorization under an individual or general TPDES permit

Submit a copy of the Notice of Termination (NOT) to the operator of any MS4 receiving the discharge within 30 days of submitting the NOT.

This site discharges to the following MS4(s): Bexar County, San Antonio Water System (SAWS)

Applications and notifications are located in Appendix A.

Transfer of Day-to-Day Operational Control

Information related to transferring operational control is located in Appendix F.

Storm Water Pollution Prevention Plan
For Espino Tract, 16-inch Offsite Water Line (Oversized)

Signage Requirements

Notices required to be posted near the entrance of the site include:

- TXR150000 Large Construction Site Notice (CSN) for Primary Operators with permit number

In areas where safety is a concern, the Construction Site Notice must be posted in a local public building or publicly accessible location near the construction site.

Edwards Aquifer Requirements

30 Texas Administrative Code (TAC) Chapter 213 is known as the Edwards Aquifer Rules and requirements for construction activities over the Edwards Aquifer Recharge Zone, Contributing Zone, and Contributing Zone within the Transition Zone.

No person may commence the construction of any regulated activity until an Edwards Aquifer protection plan or modifications to the plan as required by §213.5 of this title (relating to Required Edwards Aquifer Protection Plans, Notification, and Exemptions) or exception under §213.9 of this title (relating to Exceptions) has been filed with the appropriate regional office, and the application has been reviewed and approved by the executive director.

This site is located outside the Edwards Aquifer Recharge and Contributing Zones. A WPAP, CZP, or SCS is not required.

Tribal, Local, and State Requirements

This SWPPP is designed to comply with local and state requirements as follows.

As this site is not located in an area where separate tribal requirements may apply, no additional stormwater management controls are required to minimize the effects of stormwater runoff to affected areas.

The Texas Commission on Environmental Quality (TCEQ) TPDES General Permit TXR150000 regulations pursuant to Section 26.040 of the Texas Water Code and Section 402 of the Clean Water Act. The TCEQ TPDES General Permit TXR150000 can be found here:

<https://www.tceq.texas.gov/downloads/permitting/stormwater/general/construction/2023-cgp-txr150000.pdf>

Storm Water Pollution Prevention Plan
For Espino Tract, 16-inch Offsite Water Line (Oversized)

Retention of Records

The permittee must retain the following records for a minimum period of three (3) years from the date that a NOT is submitted as required in Part II.F.1. and 2. of this permit. For activities in which a NOT is not required, records shall be retained for a minimum period of three (3) years from the date that the operator terminates coverage under Section II.F.3. of this permit. Records include:

- A. a copy of the SWP3;
- B. all reports and actions required by this permit, including a copy of the TCEQ construction site notice;
- C. all data used to complete the NOI, if an NOI is required for coverage under this general permit; and
- D. all records of submittal of forms submitted to the operator of any MS4 receiving the discharge and to the secondary operator of a large construction site, if applicable.

Storm Water Pollution Prevention Plan
For Espino Tract, 16-inch Offsite Water Line (Oversized)

2. Site Description

Site Description

The site is located northeast of the intersection of Masterson Road and Hennersby Lane in the City of San Antonio, Bexar County, Texas 78252.

Latitude and longitude: 29.355531, -98.764893

Block of Construction	Total Acres
16-inch Offsite Water Line (Oversized)	28.93

Operator	Block of Construction	Scope of Work	Disturbed Acres
KB Home Lone Star, Inc.	16-inch Offsite Water Line (Oversized)	Developer	28.93
GENERAL CONTRACTOR TO BE DETERMINED	16-inch Offsite Water Line (Oversized)	Linear	28.93

Soil type(s)

Abbreviation	Soil Description
Fr	Loire clay loam, 0-2% slopes, occasionally flooded, is found on flood plains. This soil is well drained with a negligible runoff class, has occasional flooding, and has no frequency of ponding.
HsB	Houston Black clay, 1-3% slopes, is found on ridges. This soil is moderately well drained with a very high runoff class and has no frequency of flooding or ponding.
HsC	Houston Black clay, 3-5% slopes, is found on ridges. This soil is moderately well drained with a very high runoff class and has no frequency of flooding or ponding.
HtA	Branyon clay, 0-1% slopes, is found on stream terraces. This soil is moderately drained with a high runoff class and has no frequency of flooding or ponding.
HuB	Houston Black gravelly clay, 1-3% slopes, is found on ridges. This soil is moderately well drained with a very high runoff class and has no frequency of flooding or ponding.

Storm Water Pollution Prevention Plan
For Espino Tract, 16-inch Offsite Water Line (Oversized)

LvA	Lewisville silty clay, 0-1% slopes is found on stream terraces. This soil is well drained with a medium runoff class and has no frequency of flooding or ponding.
LvB	Lewisville silty clay, 1-3% slopes, is found on stream terraces. This soil is well drained with a low runoff class and has no frequency of flooding or ponding.
KcC2	Atco clay loam, 3-5% slopes, is found on erosion remnants on stream terraces. It is well drained with a low runoff class and has no frequency of flooding or ponding.
VcB	Sunev clay loam, 1-3% slopes, is found on stream terraces. This soil is well drained, with a low runoff class, and has no frequency of flooding or ponding.

100-Year Floodplain

Portions of the site are within the 100-year floodplain.

Receiving Waters and Description of Drainage System

Post-construction runoff discharges into Big Sous Creek and into East Branch Big Sous Creek. Some runoff is received from adjacent properties during typical storm events.

Construction stormwater runoff will discharge from the site by the sequential system(s) listed below:

- No sequential systems are planned for portions of the site due to sheet flow.

Impaired Water Body

The Texas Integrated Report describes the status of the state's waters, as required by Sections 305(b) and 303(d) of the federal Clean Water Act. It summarizes the condition of the state's surface waters, including concerns for public health, fitness for use by aquatic species and other wildlife, and specific pollutants and their possible sources.

Segmented Water Body	Impaired
Segment ID#1903-Medina River Below Medina Diversion Lake (Big Sous Creek --> Medina River)	Yes
Segment ID#1903-Medina River Below Medina Diversion Lake (East Branch Big Sous Creek --> Medina River)	Yes

Link to the Texas Integrated Report of Surface Water Quality:
<https://www.tceq.texas.gov/waterquality/assessment/22twqi/22txir>

Storm Water Pollution Prevention Plan
For Espino Tract, 16-inch Offsite Water Line (Oversized)

Link to the 2022 Texas Integrated Report – Index of Water Quality Impairments:

<https://www.tceq.texas.gov/downloads/water-quality/assessment/integrated-report-2022/2022-imp-index.pdf>

Total Maximum Daily Load (TMDL)

A TMDL is a scientifically-derived target that tells us the greatest amount of a particular substance that we can add to a waterway and still keep it healthy. The TMDL gives us a measurable way to target our efforts to protect and improve the quality of our streams, lakes, and bays.

Segment Water Body	Existing TMDL and Implementation Plan (I-Plan)	I-Plan Link
Segment ID#1903-Medina River Below Medina Diversion Lake (Big Sous Creek --> Medina River)	No	N/A
Segment ID#1903-Medina River Below Medina Diversion Lake (East Branch Big Sous Creek --> Medina River)	No	N/A

Link to the Total Maximum Daily Load Program: <https://www.tceq.texas.gov/waterquality/tmdl>

Critical Environmental Features

There are no critical environmental features on-site or within close proximity to the site.

Endangered or Threatened Species

No information was provided to Compliance Resources, Inc. regarding endangered or threatened species on-site or within close proximity to the site.

County	Category	Name	Status
Bexar County	Amphibians	Cascade Caverns salamander	Threatened
Bexar County	Amphibians	Texas salamander	Threatened

Storm Water Pollution Prevention Plan
For Espino Tract, 16-inch Offsite Water Line (Oversized)

County	Category	Name	Status
Bexar County	Birds	white-faced ibis	Threatened
Bexar County	Birds	wood stork	Threatened
Bexar County	Birds	piping plover	Threatened
Bexar County	Birds	whooping crane	Endangered
Bexar County	Birds	golden-cheeked warbler	Endangered
Bexar County	Fish	widemouth blindcat	Threatened
Bexar County	Fish	toothless blindcat	Threatened
Bexar County	Mammals	black bear	Threatened
Bexar County	Mammals	white-nosed coati	Threatened
Bexar County	Mollusks	false spike	Threatened
Bexar County	Reptiles	Cagle's map turtle	Threatened
Bexar County	Reptiles	Texas tortoise	Threatened
Bexar County	Reptiles	Texas horned lizard	Threatened

Storm Water Pollution Prevention Plan
For Espino Tract, 16-inch Offsite Water Line (Oversized)

3. Site Scope, SWPPP Responsibility, and Construction Activity Logs

Site Scope

The scope of the project includes:

- The construction of a water utility line.

The major soil disturbing events are:

- clearing and grubbing
- rough cut grading
- excavation
- regrading
- final grading

SWPPP Responsibility

KB Home Lone Star, Inc. shall be responsible for the development of a stormwater Pollution Prevention Plan.

The Owner/Developer shall be responsible for, and retain controls over any changes to site plans and the design of erosion and sedimentation controls. The Owner/Developer or its designee shall perform any additions, deletions, or changes in design of control measures. The General Contractor shall be fully responsible for daily implementation, inspection, and maintenance of the erosion and sedimentation measures or controls.

Through the identified inspection report process, the contractor shall notify the appropriate KB Home Lone Star, Inc. representative of any amendments to the SWPPP and/or control measures.

Each operator shall be fully responsible for actions of Subcontractors for which they direct on site activities.

Storm Water Pollution Prevention Plan
For Espino Tract, 16-inch Offsite Water Line (Oversized)

GENERAL SEQUENCE FOR CONSTRUCTION ACTIVITIES (16-INCH OFFSITE WATERLINE (OVERSIZED))	
CONSTRUCTION ACTIVITY	DATE ACTIVITY BEGAN
Install temporary erosion and sedimentation controls.	
Once regulatory approval has been obtained, begin clearing.	
Perform trenching; install water lines.	
Complete permanent erosion controls and restoration of site vegetation (i.e. landscaping where applicable).	
Remove/dispose of temporary erosion controls.	
Complete final site clean up.	

STABILIZATION ACTIVITIES (16-INCH OFFSITE WATERLINE (OVERSIZED) - LD)	DATE ACTIVITY BEGAN

CONSTRUCTION ACTIVITIES CEASE ON PORTION/ALL OF SITE (16-INCH OFFSITE WATERLINE (OVERSIZED) - LD)	DATE ACTIVITY CEASED

Storm Water Pollution Prevention Plan
For Espino Tract, 16-inch Offsite Water Line (Oversized)

4. Maps

Master Plan Map

(Information related to the master plan map was not made available to Compliance Resources, Inc.)

Storm Water Pollution Prevention Plan
For Espino Tract, 16-inch Offsite Water Line (Oversized)

Local Map

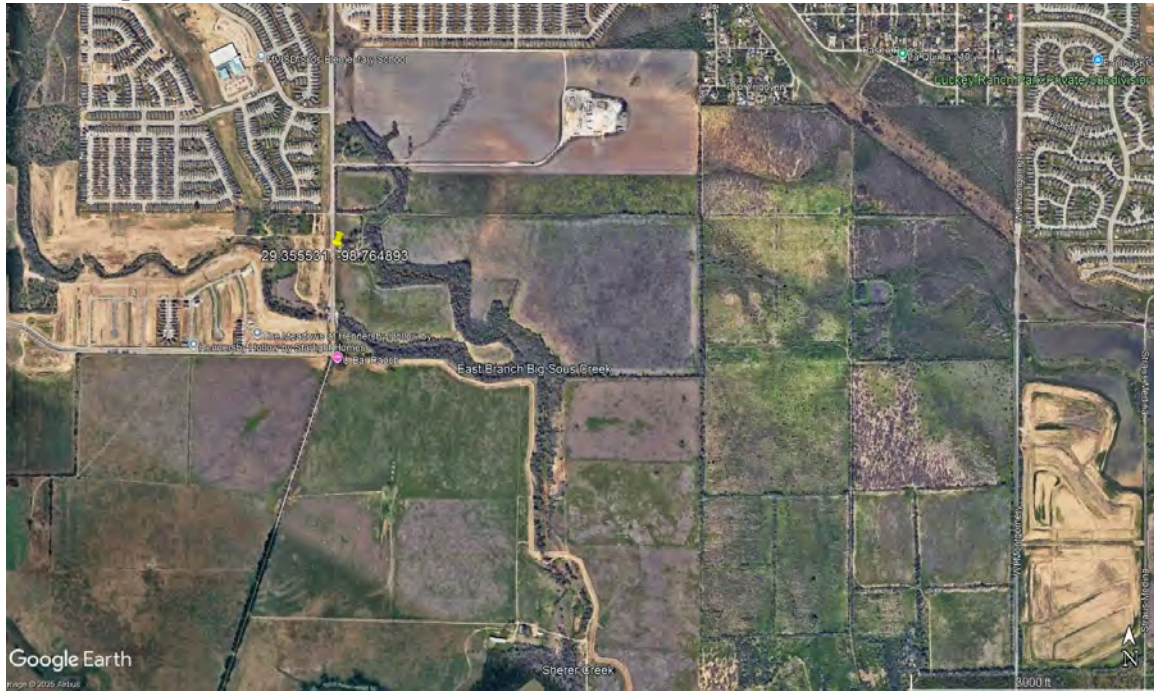

Storm Water Pollution Prevention Plan
For Espino Tract, 16-inch Offsite Water Line (Oversized)

Topographic Map

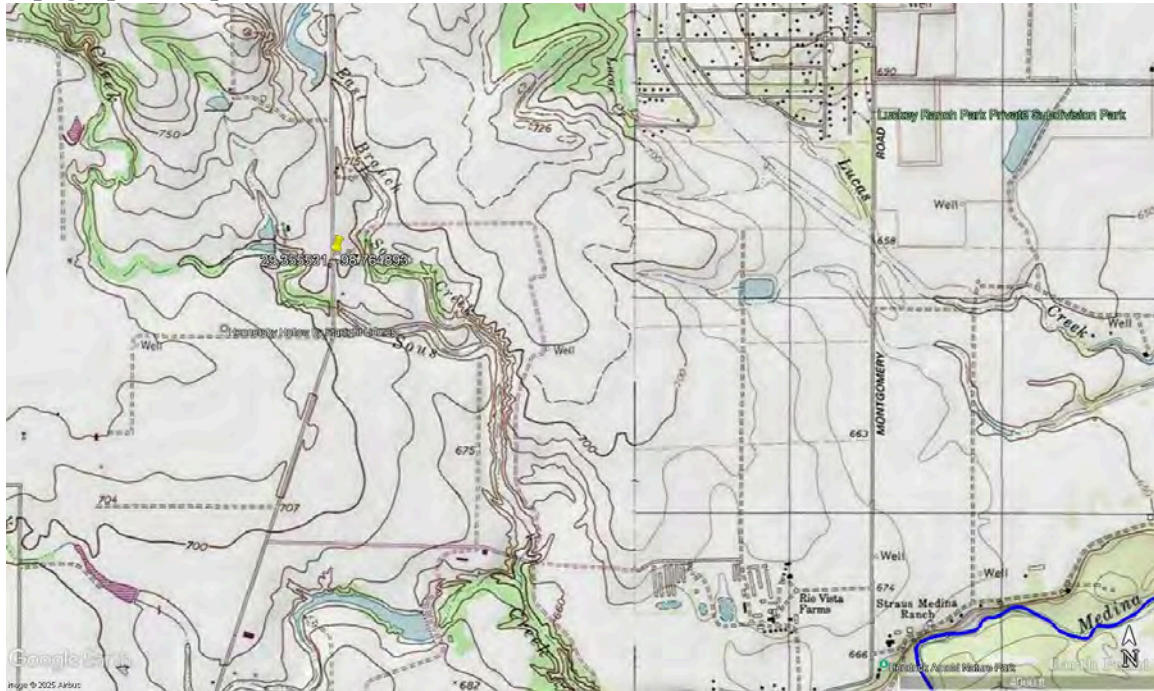

Storm Water Pollution Prevention Plan
For Espino Tract, 16-inch Offsite Water Line (Oversized)

Property Boundary Map

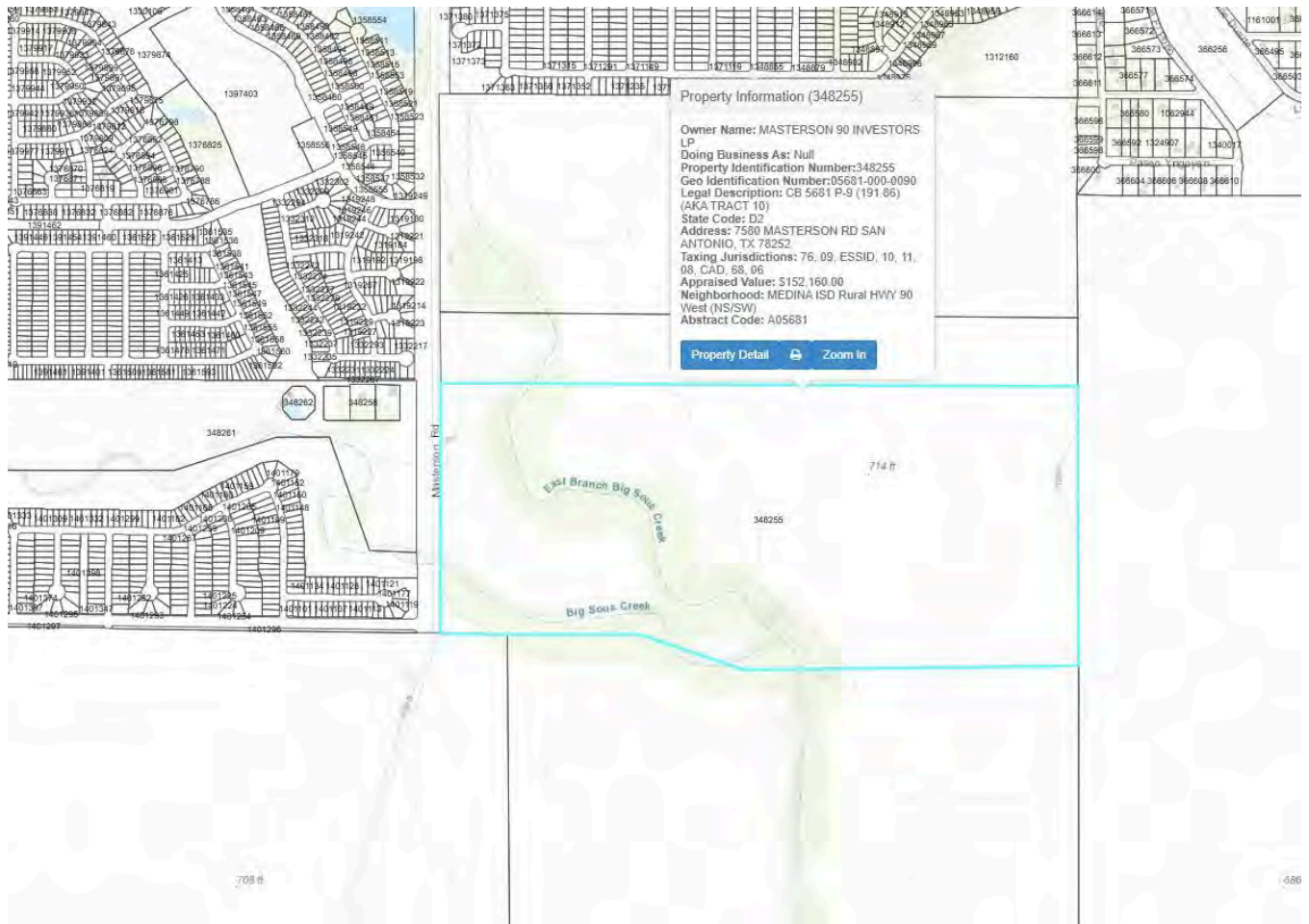

Date: Jul 24, 2025, 3:58pm User: C:\msdiesel\pdpape...
 Project: 16-INCH OFF-SITE WATER POLLUTION PREVENTION PLAN (SWP3) FOR ESPINO TRACT

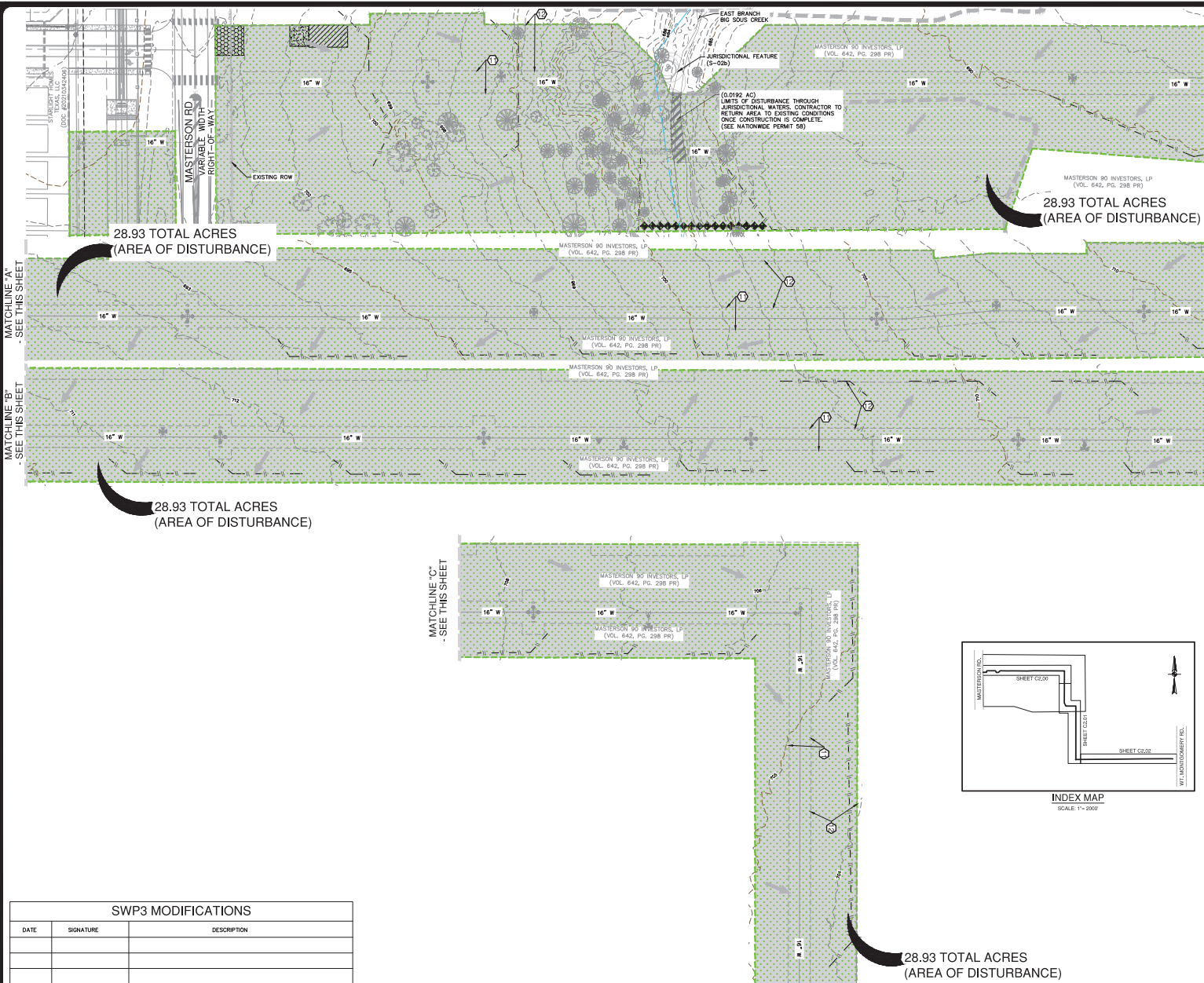

MATCHLINE "A" - SEE THIS SHEET
 MATCHLINE "B" - SEE THIS SHEET
 MATCHLINE "C" - SEE THIS SHEET
 MATCHLINE "D" - SEE SHEET C2.01

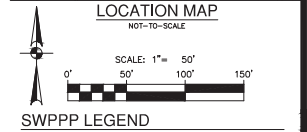
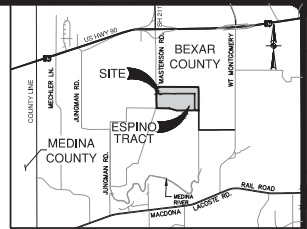

GENERAL NOTES

- DO NOT DISTURB VEGETATED AREAS (TREES, GRASS, WEEDS, BRUSH, ETC.) ANY MORE THAN NECESSARY FOR CONSTRUCTION.
- CONSTRUCTION ENTRANCE/EXIT LOCATION, CONCRETE WASH-OUT PIT, AND CONSTRUCTION EQUIPMENT AND MATERIAL STORAGE YARD TO BE DETERMINED IN THE FIELD.
- STORM WATER POLLUTION PREVENTION CONTROLS MAY NEED TO BE MODIFIED IN THE FIELD TO ACHIEVE THE DESIRED EFFECT. ALL MODIFICATIONS ARE TO BE NOTED ON THIS EXHIBIT AND SIGNED AND DATED BY THE RESPONSIBLE PARTY.
- RESPECT ENTRY/EXIT TO THE PROJECT SITE TO DESIGNATED LOCATIONS BY USE OF ADEQUATE FENCING, IF NECESSARY.
- ALL STORM WATER POLLUTION PREVENTION CONTROLS ARE TO BE MAINTAINED AND IN WORKING CONDITIONS AT ALL TIMES.
- FOR A COMPLETE LISTING OF TEMPORARY STORM WATER POLLUTION PREVENTION CONTROLS REFER TO THE TYPES STORM WATER POLLUTION PREVENTION PLAN.
- STORM WATER POLLUTION PREVENTION STRUCTURES SHOULD BE CONSTRUCTED WITHIN THE SITE BOUNDARIES. SOME OF THESE FEATURES MAY BE SHOWN OUTSIDE THE SITE BOUNDARIES ON THIS PLAN FOR VISUAL CLARITY.
- AS SOON AS PRACTICAL ALL DISTURBED SOIL THAT WILL NOT BE COVERED BY IMPERVIOUS COVER (SUCH AS PARKING AREAS, EASEMENT AREAS, TURBANKMENT SLOPES, ETC.) WILL BE STABILIZED PER APPLICABLE PROJECT SPECIFICATIONS.
- BEST MANAGEMENT PRACTICES MAY BE INSTALLED IN STAGES TO CONCOIDE WITH THE DISTURBANCE OF UPGRADEMENT AREAS.
- BEST MANAGEMENT PRACTICES MAY BE REMOVED IN STAGES ONCE THE WATERSHED FOR THAT PORTION CONTROLLED BY THE BEST MANAGEMENT PRACTICES HAS BEEN STABILIZED IN ACCORDANCE WITH TYPES REQUIREMENTS.
- UPON COMPLETION OF THE PROJECT, INCLUDING SITE STABILIZATION, AND BEFORE FINAL PAYMENT IS ISSUED, CONTRACTOR SHALL REMOVE ALL SEDIMENT AND EROSION CONTROL MEASURES, PAVING SPECIAL ATTENTION TO ROCK BERMS IN DRAINAGE FEATURES.
- WHERE VEGETATED FILTER STRIPS ARE INDICATED, CONTRACTOR SHALL VERIFY THAT SUFFICIENT VEGETATION EXISTS. OTHERWISE CONTRACTOR SHALL PLACE SILT FENCING IN LIEU OF VEGETATED FILTER STRIP.
- SHADED AREA [] DENOTES LIMITS OF DISTURBED AREAS. OTHER AREAS WITHIN THE PROJECT LIMITS WITH THE EXCEPTION OF A CONSTRUCTION EQUIPMENT AND MATERIAL STORAGE YARD, ARE NOT PART OF THIS TYPES STORM WATER POLLUTION PREVENTION PLAN (SWP3) AND WILL NOT BE DISTURBED BY CIVIL CONSTRUCTION ACTIVITIES. HOUSE CONSTRUCTION ACTIVITIES WILL REQUIRE A SEPARATE STORM WATER POLLUTION PREVENTION PLAN.

SWP3 MODIFICATIONS		
DATE	SIGNATURE	DESCRIPTION

THE ENGINEERING SEAL HAS BEEN AFFIXED TO THIS SHEET ONLY FOR THE PURPOSE OF DEMONSTRATING COMPLIANCE WITH THE TYPES-STORM WATER POLLUTION PREVENTION PLAN (SWP3) REGULATIONS.

THIS SHEET HAS BEEN PREPARED FOR PURPOSES OF THE SWP3 ONLY. ALL OTHER CIVIL ENGINEERING RELATED INFORMATION SHOULD BE ACQUIRED FROM THE APPROPRIATE SHEET IN THE CIVIL IMPROVEMENT PLANS.

PLAT NO.	N/A
JOB NO.	13240-04
DATE	JULY 2025
DESIGNER	TC
CHECKED BY	DW@DRAWN_VJ
SHEET	C2.00

PEPE-DAWSON ENGINEERS
 2205 W. LOOP 401 S. SAN ANTONIO, TX 78241 | 214.516.9000
 TEXAS ENGINEERING PROFESSIONAL SEAL

ESPINO TRACT 16-INCH OFF-SITE WATER (OVERSIZED) SAN ANTONIO, TEXAS
STORM WATER POLLUTION PREVENTION PLAN

EXHIBIT 2A

THIS DOCUMENT HAS BEEN PREPARED FROM MATERIAL THAT HAS NOT BEEN CHECKED FOR ACCURACY. THE ENGINEER HAS NOT BEEN ADVISED BY ANY OTHER PARTY OF ANY ERRORS OR OMISSIONS. THE USER ASSUMES ALL LIABILITY FOR THE USE OF THIS INFORMATION. THE ENGINEER'S LIABILITY IS LIMITED TO THE PROFESSIONAL SERVICES PROVIDED. THE USER SHALL BE RESPONSIBLE FOR OBTAINING ALL NECESSARY PERMITS AND APPROVALS FROM THE APPROPRIATE AGENCIES.

Date: Jul 24, 2025, 4:03pm, User: JC, mcdonough@papewelch.com, Project: 13240-04, Title: SWPPP, Location: Espino Tract 16-Inch Offsite Water (Oversized) - San Antonio, Texas

This document has been prepared from material that has been prepared electronically and may have been imperceptibly altered. Rely only on final, printed materials bearing the consultant's original, non-altered, and seal, which are provided by CDOT. (unless otherwise noted) - Survey Data from CDOT/MapInfo Pro, USGS Topographic Maps, USGS Data Viewer

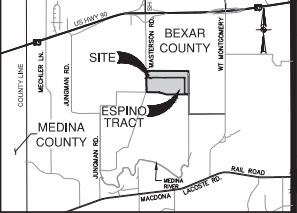
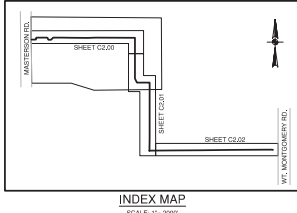
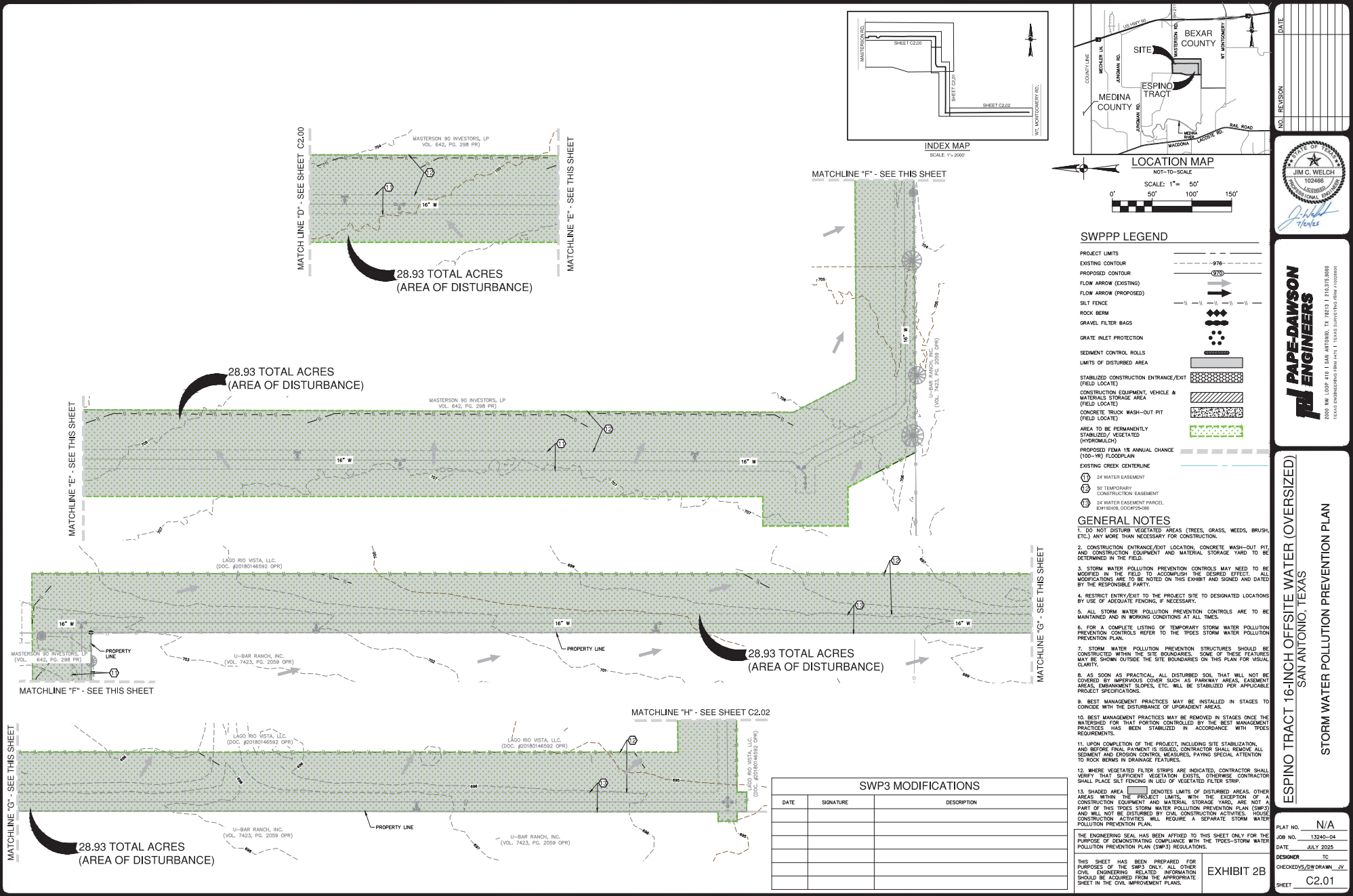

NO.	REVISION	DATE

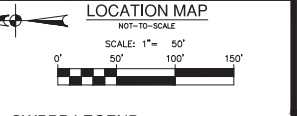

SWPPP LEGEND

PROJECT LIMITS	---
EXISTING CONTOUR	-976-
PROPOSED CONTOUR	-970-
FLOW ARROW (EXISTING)	→
FLOW ARROW (PROPOSED)	→
SILT FENCE	- - -
ROCK BERM	◆◆◆◆
GRAVEL FILTER BAGS	◆◆◆◆
GRATE INLET PROTECTION	●●●●
SEDIMENT CONTROL ROLLS	▬▬▬▬
LIMITS OF DISTURBED AREA	▬▬▬▬
STABILIZED CONSTRUCTION ENTRANCE/EXIT (FIELD LOCATE)	▬▬▬▬
CONSTRUCTION EQUIPMENT, VEHICLE & MATERIALS STORAGE AREA (FIELD LOCATE)	▬▬▬▬
CONCRETE TRUCK WASH-OUT PIT (FIELD LOCATE)	▬▬▬▬
AREA TO BE PERMANENTLY STABILIZED/VEGETATED (HYDROMULCH)	▬▬▬▬
PROPOSED FEMA 1% ANNUAL CHANCE (100-YR) FLOODPLAIN	▬▬▬▬
EXISTING CREEK CENTERLINE	---
24 WATER EASEMENT	①
50 TEMPORARY CONSTRUCTION EASEMENT	②
24 WATER EASEMENT PARCEL (BHSICR04L0004920406)	③

- ### GENERAL NOTES
- DO NOT DISTURB VEGETATED AREAS (TREES, GRASS, WEEDS, BRUSH, ETC.) ANY MORE THAN NECESSARY FOR CONSTRUCTION.
 - CONSTRUCTION ENTRANCE/EXIT LOCATION, CONCRETE WASH-OUT PIT AND CONSTRUCTION EQUIPMENT AND MATERIAL STORAGE YARD TO BE DETERMINED IN THE FIELD.
 - STORM WATER POLLUTION PREVENTION CONTROLS MAY NEED TO BE MODIFIED IN THE FIELD TO ACCOMPLISH THE DESIRED EFFECT. ALL MODIFICATIONS ARE TO BE NOTED ON THIS EXHIBIT AND DATED BY THE RESPONSIBLE PARTY.
 - RESTRICT ENTRY/EXIT TO THE PROJECT SITE TO DESIGNATED LOCATIONS BY USE OF ADEQUATE FENCING, IF NECESSARY.
 - ALL STORM WATER POLLUTION PREVENTION CONTROLS ARE TO BE MAINTAINED AND IN WORKING CONDITIONS AT ALL TIMES.
 - FOR A COMPLETE LISTING OF TEMPORARY STORM WATER POLLUTION PREVENTION PLAN.
 - STORM WATER POLLUTION PREVENTION STRUCTURES SHOULD BE CONSTRUCTED WITHIN THE SITE BOUNDARIES. SOME OF THESE FEATURES MAY BE SHOWN OUTSIDE THE SITE BOUNDARIES ON THIS PLAN FOR VISUAL CLARITY.
 - AS SOON AS PRACTICAL, ALL DISTURBED SOIL THAT WILL NOT BE COVERED BY IMPERVIOUS COVER SUCH AS PARKWAY AREAS, EASEMENT AREAS, EASEMENT SLOPES, ETC. WILL BE STABILIZED PER APPLICABLE PROJECT SPECIFICATIONS.
 - BEST MANAGEMENT PRACTICES MAY BE INSTALLED IN STAGES TO CONSIDER WITH THE DISTURBANCE OF URGENT AREAS.
 - BEST MANAGEMENT PRACTICES MAY BE REMOVED IN STAGES ONCE THE WATERSHED FOR THAT PORTION CONTROLLED BY THE BEST MANAGEMENT PRACTICES HAS BEEN STABILIZED.
 - UPON COMPLETION OF THE PROJECT, INCLUDING SITE STABILIZATION, AND BEFORE FINAL PAYMENT IS ISSUED, CONTRACTOR SHALL REMOVE ALL SEDIMENT AND EROSION CONTROL MEASURES, PAYING SPECIAL ATTENTION TO ROCK BERMS IN DRAINAGE FEATURES.
 - WHERE VEGETATED FILTER STRIPS ARE INDICATED, CONTRACTOR SHALL VERIFY THAT SUFFICIENT VEGETATION EXISTS, OTHERWISE CONTRACTOR SHALL PLACE SILT FENCING IN LIEU OF VEGETATED FILTER STRIP.
 - SHADED AREA DENOTES LIMITS OF DISTURBED AREAS. OTHER AREAS WITHIN THE PROJECT LIMITS WITH THE EXCEPTION OF A CONSTRUCTION EQUIPMENT AND MATERIAL STORAGE YARD, ARE NOT PART OF THIS TRIP'S STORM WATER POLLUTION PREVENTION PLAN (SWPPP) AND WILL NOT BE DISTURBED BY CIVIL CONSTRUCTION ACTIVITIES. HOUSE CONSTRUCTION ACTIVITIES WILL REQUIRE A SEPARATE STORM WATER POLLUTION PREVENTION PLAN.

SWP3 MODIFICATIONS

DATE	SIGNATURE	DESCRIPTION

THE ENGINEERING SEAL HAS BEEN AFFIXED TO THIS SHEET ONLY FOR THE PURPOSE OF DEMONSTRATING COMPLIANCE WITH THE TRIP'S-STORM WATER POLLUTION PREVENTION PLAN (SWPPP) REGULATIONS.

THIS SHEET HAS BEEN PREPARED FOR PURPOSES OF THE SWPPP ONLY. ALL OTHER CIVIL ENGINEERING RELATED INFORMATION SHOULD BE ACQUIRED FROM THE APPROPRIATE SHEET IN THE CIVIL IMPROVEMENT PLANS.

EXHIBIT 2B

ESPINO TRACT 16-INCH OFFSITE WATER (OVERSIZED)
SAN ANTONIO, TEXAS
STORM WATER POLLUTION PREVENTION PLAN

PLAT NO.	N/A
JOB NO.	13240-04
DATE	JULY 2025
DESIGNER	TC
CHECKED BY	DW/DRA/ANN JV
SHEET	C2.01

Date: Jul 24, 2025, 4:52pm, User: jg_mcdonald@papeng.com, Plot: P:\132465\132465.dwg, Plot Style: 132465.ctb

This document has been prepared from material that has been scanned electronically and may have been inadvertently altered. Rely only on final, unmodified materials supplied by the consultant's original sources. No scale, color, or other information provided by Google, unless otherwise noted. Source: 3D/Orthophoto/DEM Data from OrthoImage Pro, USA Farm Service Agency.

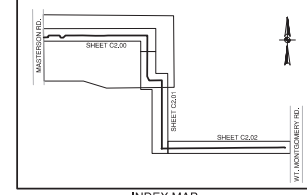

INDEX MAP
SCALE: 1" = 200'

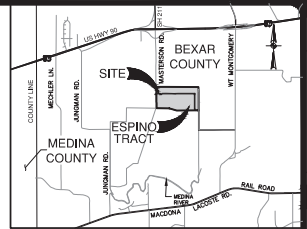

LOCATION MAP
NOT-TO-SCALE

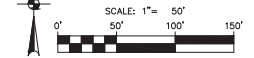

SWPPP LEGEND

- PROJECT LIMITS
- EXISTING CONTOUR
- PROPOSED CONTOUR
- FLOW ARROW (EXISTING)
- FLOW ARROW (PROPOSED)
- SILT FENCE
- ROCK BERM
- GRAVEL FILTER BAGS
- GRATE INLET PROTECTION
- SEDIMENT CONTROL ROLLS
- LIMITS OF DISTURBED AREA
- STABILIZED CONSTRUCTION ENTRANCE/EXIT (FIELD LOCATE)
- CONSTRUCTION EQUIPMENT, VEHICLE & MATERIALS STORAGE AREA (FIELD LOCATE)
- CONCRETE TRUCK WASH-OUT PIT (FIELD LOCATE)
- AREA TO BE PERMANENTLY STABILIZED/VEGETATED (HYDROMULCH)
- PROPOSED FEMA 1% ANNUAL CHANCE (100-YR) FLOODPLAIN
- EXISTING CREEK CENTERLINE
- 24" WATER EASEMENT
- 50' TEMPORARY CONSTRUCTION EASEMENT
- WATER EASEMENT (PARCEL # 110248, DDC0P2506)

GENERAL NOTES

1. DO NOT DISTURB VEGETATED AREAS (TREES, GRASS, WEEDS, BRUSH, ETC.) ANY MORE THAN NECESSARY FOR CONSTRUCTION.
2. CONSTRUCTION ENTRANCE/EXIT LOCATION, CONCRETE WASH-OUT PIT, AND CONSTRUCTION EQUIPMENT AND MATERIAL STORAGE YARD TO BE DETERMINED IN THE FIELD.
3. STORM WATER POLLUTION PREVENTION CONTROLS MAY NEED TO BE MODIFIED IN THE FIELD TO ACCOMPLISH THE DESIRED EFFECT. ALL MODIFICATIONS ARE TO BE NOTED ON THIS EXHIBIT AND SIGNED AND DATED BY THE RESPONSIBLE PARTY.
4. RESTRICT ENTRY/EXIT TO THE PROJECT SITE TO DESIGNATED LOCATIONS BY USE OF ADEQUATE FENCING, IF NECESSARY.
5. ALL STORM WATER POLLUTION PREVENTION CONTROLS ARE TO BE MAINTAINED AND IN WORKING CONDITIONS AT ALL TIMES.
6. FOR A COMPLETE LISTING OF TEMPORARY STORM WATER POLLUTION PREVENTION CONTROLS REFER TO THE TPO'S STORM WATER POLLUTION PREVENTION PLAN.
7. STORM WATER POLLUTION PREVENTION STRUCTURES SHOULD BE CONSTRUCTED WITHIN THE SITE BOUNDARIES. SOME OF THESE FEATURES MAY BE SHOWN OUTSIDE THE SITE BOUNDARIES ON THIS PLAN FOR VISUAL CLARITY.
8. AS SOON AS PRACTICAL, ALL DISTURBED SOIL THAT WILL NOT BE COVERED BY IMPERVIOUS COVER SUCH AS PARKWAY AREAS, EASEMENT AREAS, CURBMENT SLOPES, ETC., WILL BE STABILIZED PER APPLICABLE PROJECT SPECIFICATIONS.
9. BEST MANAGEMENT PRACTICES MAY BE INSTALLED IN STAGES TO CONCLUDE WITH THE DISTURBANCE OF UPSTREAM AREAS.
10. BEST MANAGEMENT PRACTICES MAY BE REMOVED IN STAGES ONCE THE WATERSHED FOR THAT PORTION CONTROLLED BY THE BEST MANAGEMENT PRACTICES HAS BEEN STABILIZED IN ACCORDANCE WITH TPDES REQUIREMENTS.
11. UPON COMPLETION OF THE PROJECT, INCLUDING SITE STABILIZATION, AND BEFORE FINAL PAYMENT IS ISSUED, CONTRACTOR SHALL REMOVE ALL SEDIMENT AND EROSION CONTROL MEASURES, PAYING SPECIAL ATTENTION TO ROCK BERMS IN DRAINAGE FEATURES.
12. WHERE VEGETATED FILTER STRIPS ARE INDICATED, CONTRACTOR SHALL VERIFY THAT SUFFICIENT VEGETATION EXISTS. OTHERWISE, CONTRACTOR SHALL PLACE SILT FENCING IN LIEU OF VEGETATED FILTER STRIP.
13. SHADED AREA [] DENOTES LIMITS OF DISTURBED AREAS. OTHER AREAS WITHIN THE PROJECT LIMITS WITH THE EXCEPTION OF A CONSTRUCTION EQUIPMENT AND MATERIAL STORAGE YARD, ARE NOT A PART OF THIS TPO'S STORM WATER POLLUTION PREVENTION PLAN (SWPP) AND WILL NOT BE DISTURBED BY CIVIL CONSTRUCTION ACTIVITIES. HOUSE CONSTRUCTION ACTIVITIES WILL REQUIRE A SEPARATE STORM WATER POLLUTION PREVENTION PLAN.

SWP3 MODIFICATIONS

DATE	SIGNATURE	DESCRIPTION

THE ENGINEERING SEAL HAS BEEN AFFIXED TO THIS SHEET ONLY FOR THE PURPOSE OF DEMONSTRATING COMPLIANCE WITH THE TPO'S STORM WATER POLLUTION PREVENTION PLAN (SWPP) REGULATIONS.

THIS SHEET HAS BEEN PREPARED FOR PURPOSES OF THE SWP3 ONLY. ALL OTHER CIVIL ENGINEERING RELATED INFORMATION SHOULD BE ACQUIRED FROM THE APPROPRIATE SHEET IN THE CIVIL IMPROVEMENT PLANS.

EXHIBIT 2C

NO.	REVISION	DATE

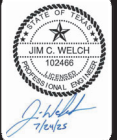

ESPIÑO TRACT 16-INCH OFF-SITE WATER (OVERSIZED)
SAN ANTONIO, TEXAS
STORM WATER POLLUTION PREVENTION PLAN

PLAT NO. N/A
JOB NO. 13240-04
DATE JULY 2025
DESIGNER TC
CHECKED/DRAWN/JV
SHEET C2.02

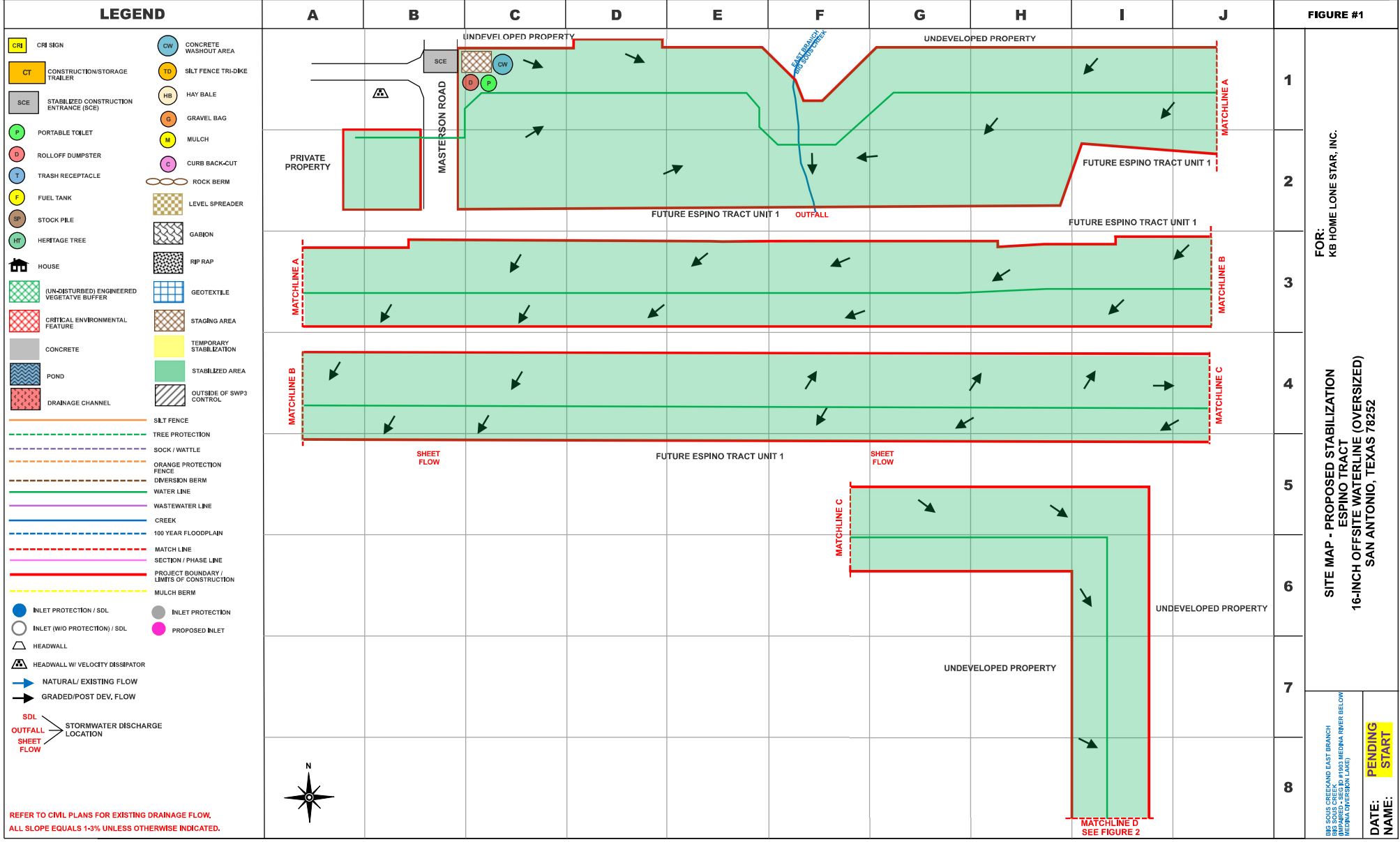

FOR:
KB HOME LONE STAR, INC.

SITE MAP - PROPOSED STABILIZATION
ESPINO TRACT
16-INCH OFFSITE WATERLINE (OVERSIZED)
SAN ANTONIO, TEXAS 78252

BIG SOUS CREEK AND EAST BRANCH
W/IMPARED + SEG B/ PROG MEDINA RIVER BELOW
W/IMPARED (OVERSIZED) (LARGE)

DATE: PENDING
NAME: START

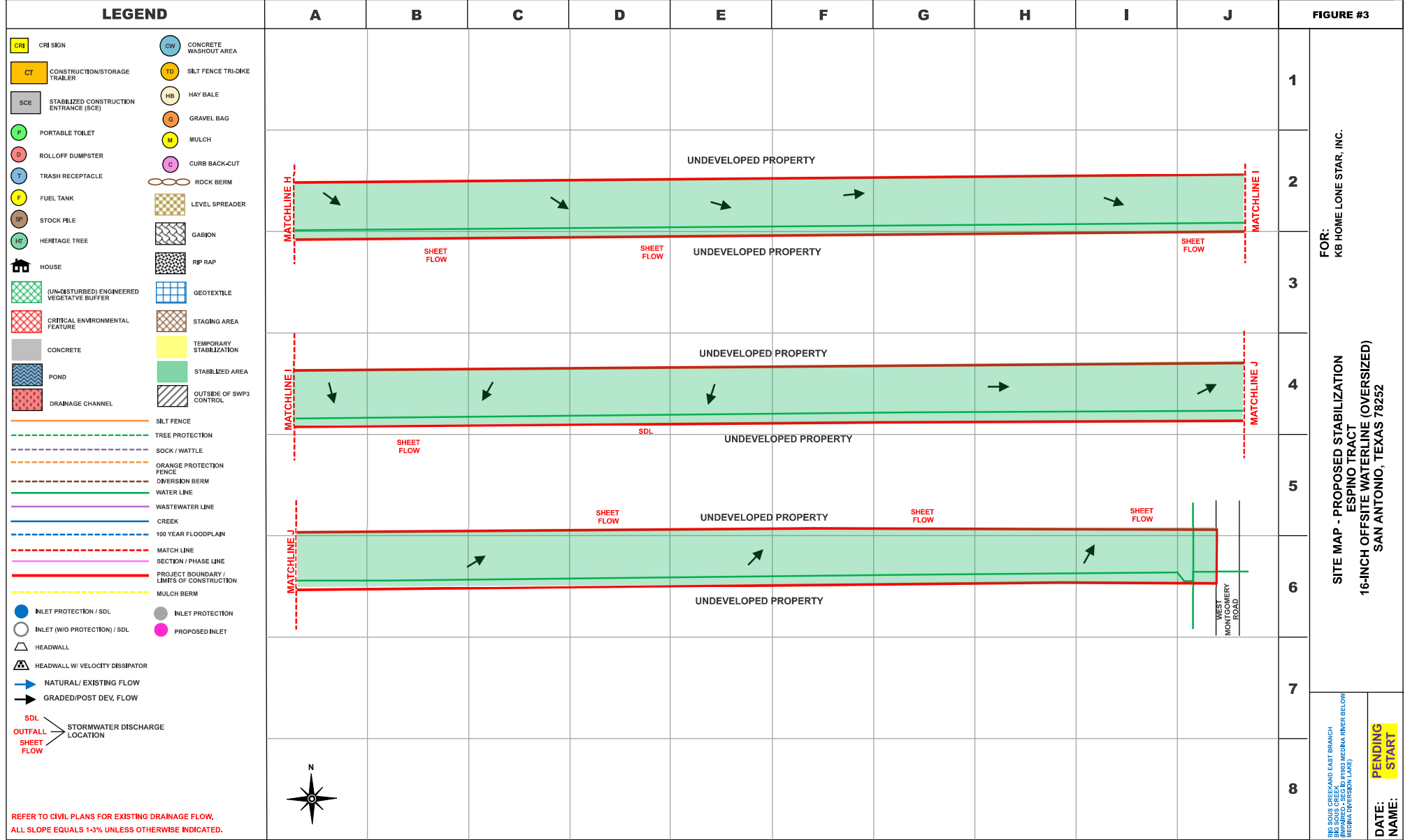

BB SOUS CREEK AND EAST BRANCH
BB SOUS CREEK, W/ BB SOUS CREEK AND
MEDINA DIVERSION LAKE

DATE: PENDING
NAME: START

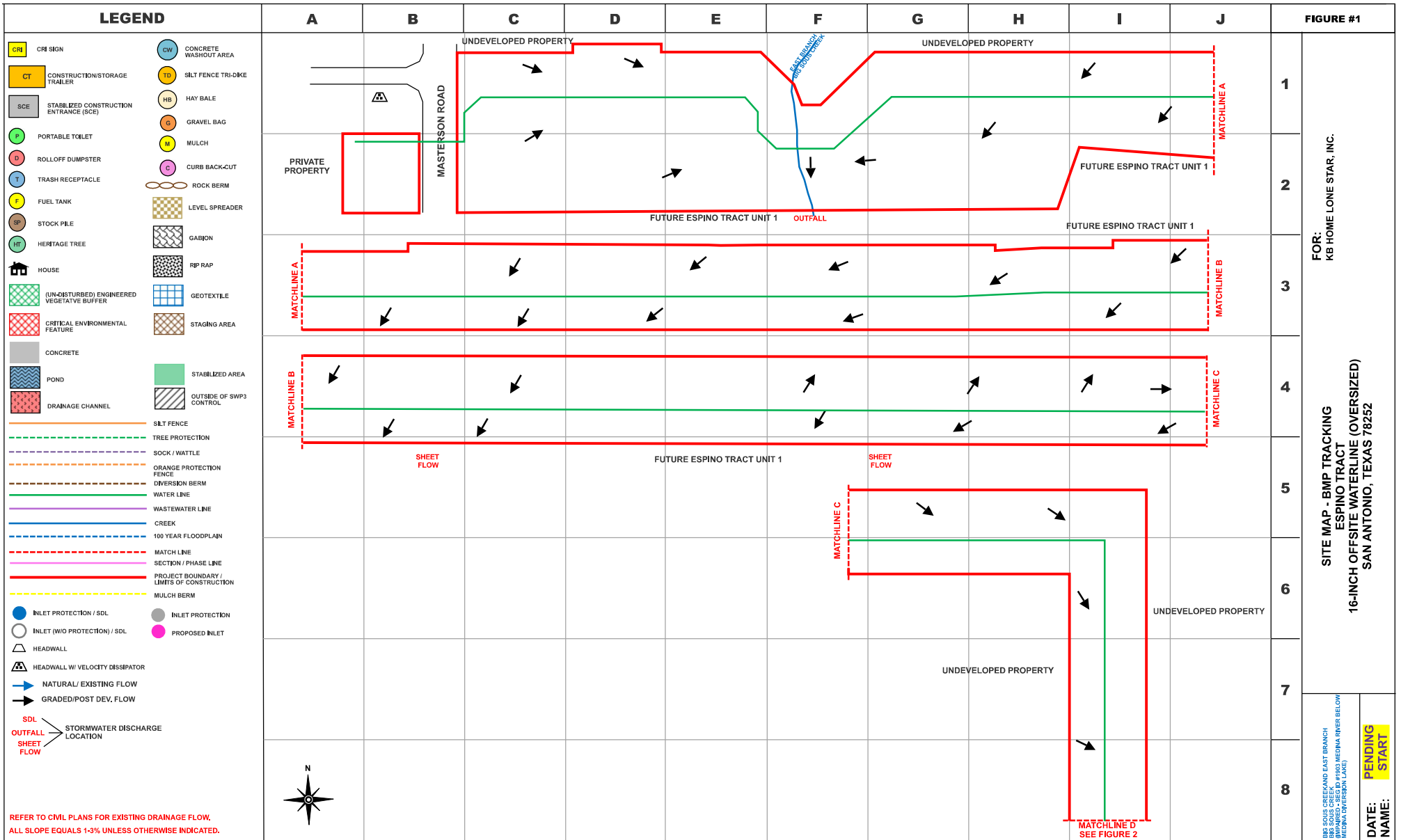

FOR:
KB HOME LONE STAR, INC.

SITE MAP - BMP TRACKING
ESPINO TRACT
16-INCH OFFSITE WATERLINE (OVERSIZED)
SAN ANTONIO, TEXAS 78252

BIG SOUS CREEK AND EAST BRANCH
BIG SOUS CREEK
(IMPAIRED - SEG B) PROPOSED MEDINA RIVER BELOW
MEDINA (OVERSIZED GAGE)

DATE: PENDING
NAME: START

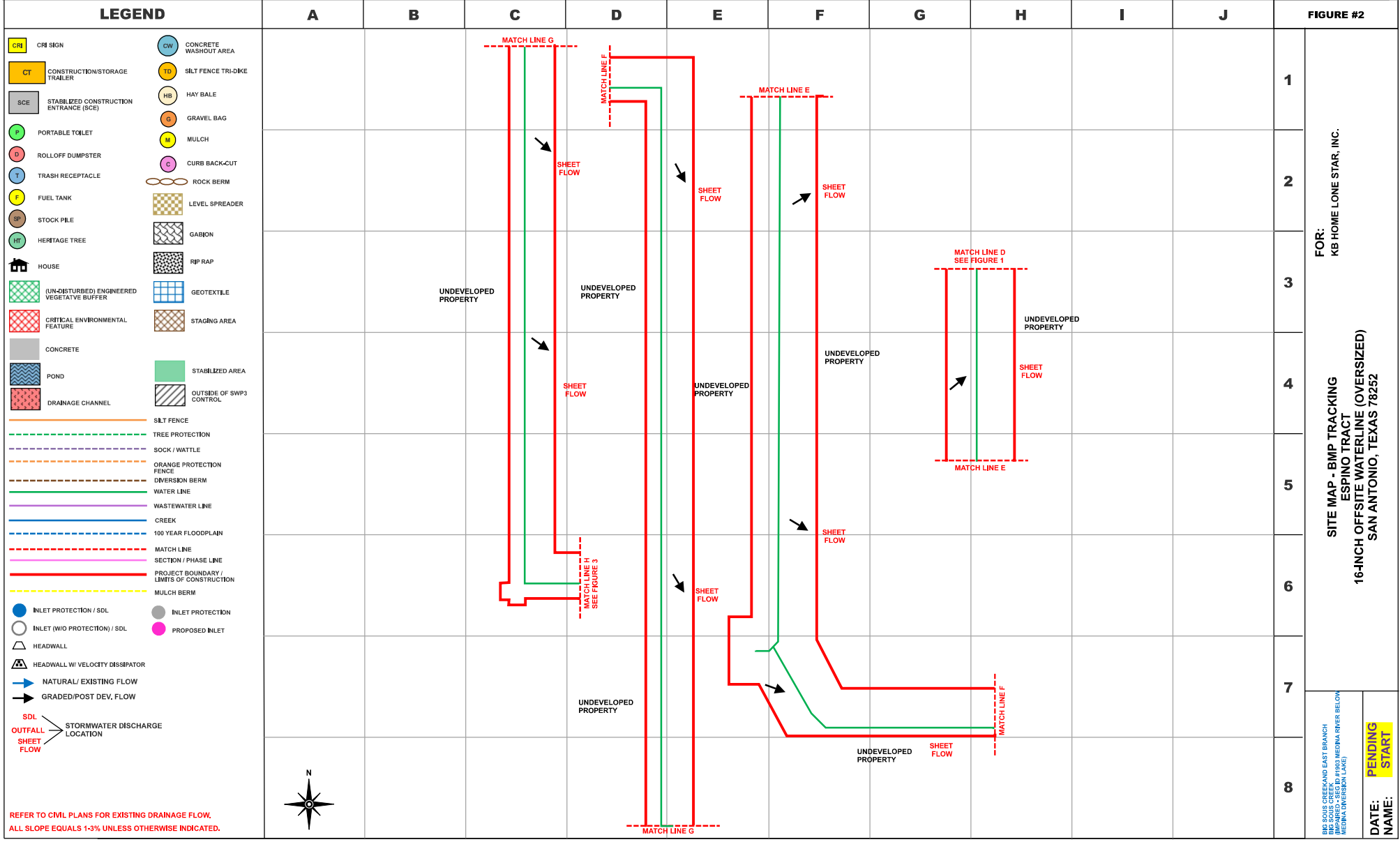

FOR:
KB HOME LONE STAR, INC.

SITE MAP - BMP TRACKING
ESPINO TRACT
16-INCH OFFSITE WATERLINE (OVERSIZED)
SAN ANTONIO, TEXAS 78252

BIG SOUS CREEK AND EAST BRANCH
BIG SOUS CREEK, W/ EAST BRANCH
W/ MEDINA RIVER BELOW
MEDINA DIVERSION LAKE

DATE: PENDING
NAME: START

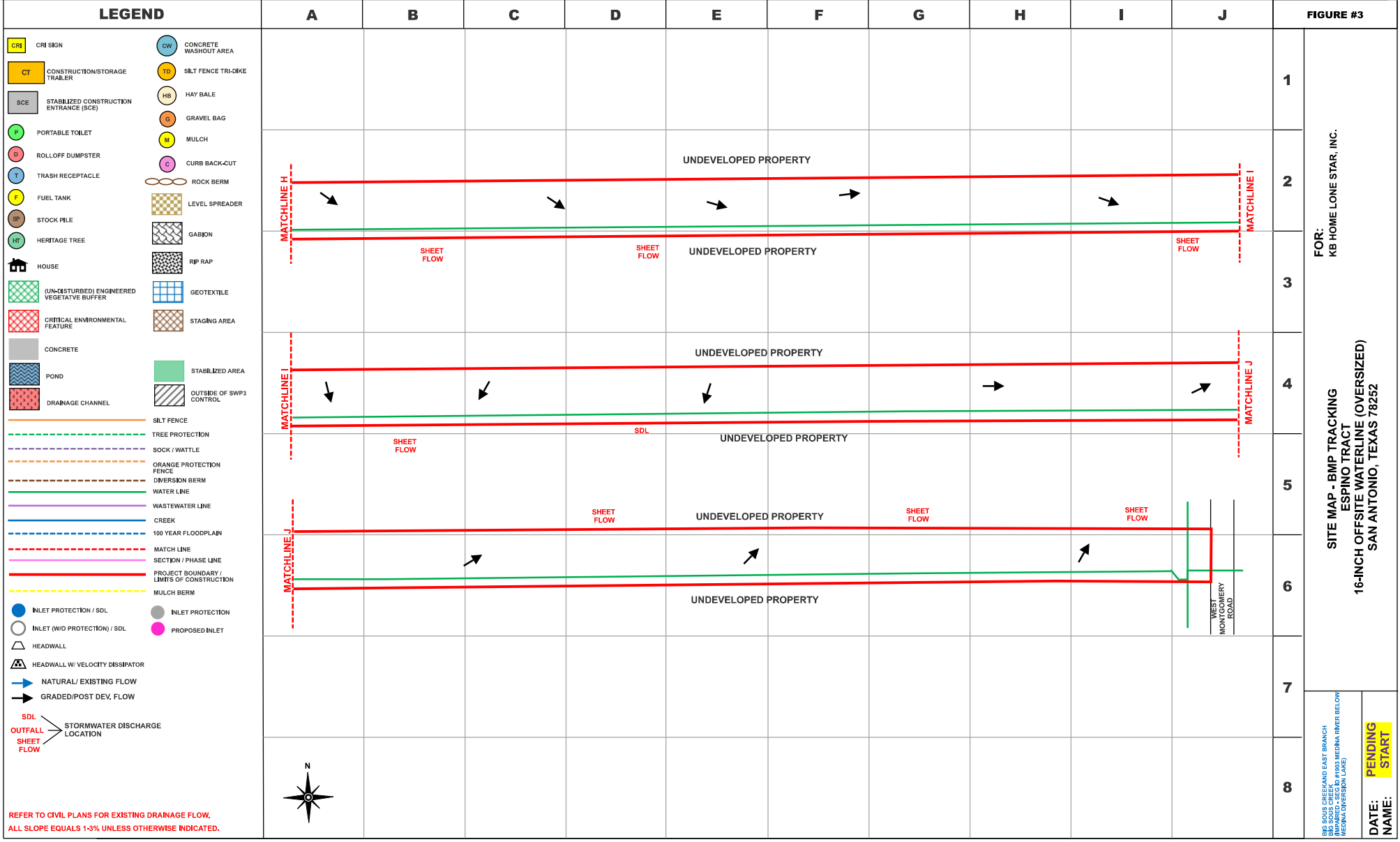

FOR:
KB HOME LONE STAR, INC.

SITE MAP - BMP TRACKING
ESPINO TRACT
16-INCH OFFSITE WATERLINE (OVERSIZED)
SAN ANTONIO, TEXAS 78252

BIG SOUS CREEK AND EAST BRANCH
BIG SOUS CREEK, W/ BASS MEDIAN RIVER BELOW
MEDINA DIVERSION LAKE

DATE: PENDING
NAME: START

Storm Water Pollution Prevention Plan
For Espino Tract, 16-inch Offsite Water Line (Oversized)

5. Best Management Practices

Erosion and Sediment Control Requirements Applicable to All Sites

Except as provided in 40 CFR §§ 125.30-125.32, any discharge regulated under this general permit, with the exception of sites that obtained waivers based on low rainfall erosivity, must achieve, at a minimum, the following effluent limitations representing the degree of effluent reduction attainable by application of the best practicable control technology currently available (BPT). The BPT are also required by and must satisfy the Effluent Limitations Guideline (ELG) permitting requirement for application of 40 CFR § 450.24 New Source Performance Standards (NSPS), 40 CFR § 450.22 Best Available Technology Economically Achievable (BAT), and 40 CFR § 450.23 Best Conventional Pollutant Control Technology (BCT).

1. Erosion and sediment controls: Design, install, and maintain effective erosion controls and sediment controls to minimize the discharge of pollutants. At a minimum, such controls must be designed, installed, and maintained to:
 1. Control stormwater volume and velocity within the site to minimize soil erosion in order to minimize pollutant discharges;
 2. Control stormwater discharges, including both peak flow rates and total stormwater volume, to minimize channel and streambank erosion and scour in the immediate vicinity of discharge point(s);
 3. Minimize the amount of soil exposed during construction activity;
 4. Minimize the disturbance of steep slopes;
 5. Minimize sediment discharges from the site. The design, installation, and maintenance of erosion and sediment controls must address factors such as the amount, frequency, intensity and duration of precipitation, the nature of resulting stormwater runoff, and soil characteristics, including the range of soil particle sizes expected to be present on the site;
 6. Provide and maintain appropriate natural buffers around surface water in the state. Direct stormwater to vegetated areas and maximize stormwater infiltration to reduce pollutant discharges, unless infeasible. ***If providing buffers is infeasible, the permittee shall document the reason that natural buffers are infeasible and shall implement additional erosion and sediment controls to reduce sediment load;***
 7. Preserve native topsoil at the site, unless the intended function of a specific area of the site dictates that the topsoil be disturbed or removed, or it is infeasible; and
 8. Minimize soil compaction. In areas of the construction site where final vegetative stabilization will occur or where infiltration practices will be installed, either:
 - a. Restrict vehicle and equipment use to avoid soil compaction; or
 - b. Prior to seeding or planting areas of exposed soil that have been compacted, use techniques that condition the soils to support vegetation growth, if necessary and feasible;

Minimizing soil compaction is not required where the intended function of a specific area of the site dictates that it be compacted.

9. TCEQ does not consider stormwater control features (e.g. stormwater conveyance channels, storm drain inlets, sediment basins) to constitute “surface water” for the purposes of triggering the buffer requirement in Part III.G.1.(f) above.

2. Soil stabilization. Stabilization of disturbed areas must, at a minimum, be initiated immediately whenever any clearing, grading, excavating, or other earth disturbing activities have

Storm Water Pollution Prevention Plan
For Espino Tract, 16-inch Offsite Water Line (Oversized)

permanently ceased on any portion of the site, or temporarily ceased on any portion of the site and will not resume for a period exceeding 14 calendar days. In the context of this requirement, “immediately” means as soon as practicable, but no later than the end of the next work day, following the day when the earth disturbing activities have temporarily or permanently ceased. Temporary stabilization must be completed no more than 14 calendar days after initiation of soil stabilization measures, and final stabilization must be achieved prior to termination of permit coverage. In arid, semi-arid, and drought-stricken areas where initiating vegetative stabilization measure immediately is infeasible, alternative non-vegetative stabilization measures must be employed as soon as practicable. Refer to Part III.F.2.(b) for complete erosion control and stabilization practice requirements. In limited circumstances, stabilization may not be required if the intended function of a specific area of the site necessitates that it remain disturbed.

3. Dewatering. Discharges from dewatering activities, including discharges from dewatering of trenches and excavations, are prohibited, unless managed by appropriate controls to address sediment and prevent erosion. Operators must perform an inspection of the dewatering controls once per day while the dewatering discharge occurs as described in Part III.F.7. of this general permit.

4. Pollution prevention measures. Design, install, implement, and maintain effective pollution prevention measures to minimize the discharge of pollutants. At a minimum, such measures must be designed, installed, implemented, and maintained to:

1. Minimize the discharge of pollutants from equipment and vehicle washing, wheel wash water, and other wash waters. Wash waters must be treated in a sediment basin or alternative control that provides equivalent or better treatment prior to discharge;
2. Minimize the exposure of building materials, building products, construction wastes, trash, landscape materials, fertilizers, pesticides, herbicides, detergents, sanitary waste, and other materials present on the site to precipitation and to stormwater;
3. Minimize the exposure of waste materials by closing waste container lids at the end of the workday and during storm events. For waste containers that do not have lids, where the container itself is not sufficiently secure enough to prevent the discharge of pollutants absent a cover and could leak, the permittee must provide either a cover (e.g., a tarp, plastic sheeting, temporary roof) to minimize exposure of wastes to precipitation, stormwater, and wind, or a similarly effective means designed to minimize the discharge of pollutants (e.g., secondary containment);
4. Minimize exposure of wastes by implementing good housekeeping measures. Wastes must be cleaned up and disposed of in designated waste containers on days of operation at the site. Wastes must be cleaned up immediately if containers overflow;
5. Minimize the discharge of pollutants from spills and leaks and implement chemical spill and leak prevention and response procedures. Where a leak, spill, or other release containing a hazardous substance or oil in an amount equal to or in excess of a reportable quantity established under either 40 CFR Part 110, 40 CFR Part 117, or 40 CFR Part 302 occurs during a 24-hour period, you must notify the National Response Center (NRC) at (800) 424-8802 in accordance with the requirements of 40 CFR Part 110, 40 CFR Part 117, and 40 CFR Part 302 as soon as you have knowledge of the release. You must also, within seven (7) calendar days of knowledge of the release, provide a description of the release, the circumstances leading to the release, and the date of the release; and
6. Minimize exposure of sanitary waste by positioning portable toilets so that they are secure and will not be tipped or knocked over, and so that they are located away from surface water in the state and stormwater inlets or conveyances.

Storm Water Pollution Prevention Plan
For Espino Tract, 16-inch Offsite Water Line (Oversized)

5. Prohibited discharges. The following discharges are prohibited:
1. Wastewater from wash out of concrete, unless managed by an appropriate control;
 2. Wastewater from wash out and cleanout of stucco, paint, form release oils, curing compounds and other construction materials;
 3. Fuels, oils, or other pollutants used in vehicle and equipment operation and maintenance;
 4. Soaps or solvents used in vehicle and equipment washing; and
 5. Toxic or hazardous substances from a spill or other release.
6. Surface outlets. When discharging from basins and impoundments, utilize outlet structures that withdraw water from the surface, unless infeasible. If infeasible, the permittee must provide documentation in the SWP3 to support the determination, including the specific conditions or time periods when this exception will apply.

Concrete Truck Wash Out Requirements

This general permit authorizes the land disposal of wash out from concrete trucks at construction sites regulated under this general permit, provided the following requirements are met. Any discharge of concrete production wastewater to surface water in the state must be authorized under a separate TCEQ general permit or individual permit.

- A. Discharge of concrete truck wash out water to surface water in the state, including discharge to storm sewers, is prohibited by this general permit.
- B. Concrete truck wash out water shall be disposed in areas at the construction site where structural controls have been established to prevent discharge to surface water in the state, or to areas that have a minimal slope that allow infiltration and filtering of wash out water to prevent discharge to surface water in the state. Structural controls may consist of temporary berms, temporary shallow pits, temporary storage tanks with slow rate release, or other reasonable measures to prevent runoff from the construction site.
- C. Wash out of concrete trucks during rainfall events shall be minimized. The discharge of concrete truck wash out water is prohibited at all times, and the operator shall insure that its BMPs are sufficient to prevent the discharge of concrete truck wash out as the result of rainfall or stormwater runoff.
- D. The disposal of wash out water from concrete trucks, made under authorization of this general permit must not cause or contribute to groundwater contamination.
- E. If a SWP3 is required to be implemented, the SWP3 shall include concrete wash out areas on the associated site map.

Storm Water Pollution Prevention Plan
For Espino Tract, 16-inch Offsite Water Line (Oversized)

Potential Pollutant Sources

Potential pollution sources associated with the site include the following:

- **Soil disturbing activities** – such as clearing of vegetation, grading/excavation of the lot in preparation for construction, and landscaping. These activities typically expose soil and sediment particles to precipitation which can then move (erode) the pollutants downhill, potentially into stormwater conveyances and receiving waters.
- **Equipment storage** – such as earth-moving equipment, delivery vehicles, power tools, etc. Much of this equipment contains petroleum-based fuels or lubricants, which when exposed to precipitation can discharge with the stormwater runoff.
- **Paving** – asphalt paving activities during road construction can result in the discharge of hydrocarbons with stormwater runoff.
- **Concrete truck washout** – runoff from the cleanouts of concrete trucks can result in sediment, debris, and excessively high pH discharge with stormwater runoff.
- **Vehicle and equipment maintenance** – such as fueling, lubrication, and repair. If conducted on site, accidental spills or improper disposal of automotive fluids or petroleum products can significantly impact stormwater runoff and receiving waters.
- **Material storage** – such as storage of concrete and concrete products, metal reinforcing materials such as rebar and welded wire fabric, lumber, plastic (PVC), metal pipe and fittings, rock, gravel, sand, soil, petroleum products like lubricants, fuel, oil-based paints and paint thinners, miscellaneous chemicals or products including latex paint, joint compound, adhesives, fertilizers, etc. Some materials may contain hazardous or toxic ingredients which can pollute surface waters or make source water unsafe for consumption. Other materials may contain ingredients which are non-toxic but can still impact stormwater conveyances by silting or clogging them, causing flooding, or using up needed oxygen for aquatic life to survive in the receiving waters.
- **Waste generation, storage and disposal** – such as excess fill material, soil contaminated by spilled petroleum, leftover chemicals, cement, miscellaneous trash and debris, and human wastes. All these materials can negatively impact the runoff leaving the construction site as described above.

Control of these potential pollution sources, thereby preventing contamination of stormwater runoff is the goal of this plan and will be described in detail in this section of the SWPPP.

**Storm Water Pollution Prevention Plan
For Espino Tract, 16-inch Offsite Water Line (Oversized)**

Potential Pollutant Sources Onsite:

	Aromatic Hydrocarbon Toluene
Hi Solids Polyester	
Methyl Amyl Ketone	Acrylic Sealant
2-Butoxy-Ethyl Acetate	Toluene
Normal Butyl Alcohol	
Aromatic Hydrocarbon 150	High Performance Glazing Tape Sealant
1-Methoxy-2-Propanol Acetate	Carbon
Xylol	
Aromatic 100 Solvent	General Purpose Glazing Sealant
Diethylene Glycol N-Butyl Ether	Silicone Polymer
Toluol	Polydimethylsiloxane
Oxo-Hexyl Acetate	Silica
	Silane
Aluminum Alloys	Oximino Silane
See attachment	
	Transmission Fluid
Quick Dry Floor Sweep	Light Paraffinic Petroleum
Hydrotreated Petroleum Distillates	Heavy Paraffinic Petroleum
	Light Napthenic Petroleum
Acetone	Metacrylic Acid
Silicone Sealant	Motor Oil
Silicone Polymer	Alkenysuccinimide Dispersant
Polydimethylsiloxane	Heavy Paraffinic Petroleum
Silica	
Ethyltriacetoxsilane	Soluble Oil D
Acetoxysilane with oligomers	Sodium Petroleum Sulfonate
Titanium Dioxide	Heavy Paraffinic Petroleum
Carbon	
	Lumber
Adhesive-Sealant	
Dimethyl Siloxane OH Terminated	Glass
Methyltriacetoxy Silane	
Titanium Dioxide	Fiberglass Insulation
Ethyltriacetoxsilane	
Polydimethylsiloxane	Dry-wall material
Acrylic Seam Sealer	Oil and Water Based Paint
Acrylic Resin/Toluene Solution	
Toluene	Concrete
Silicon Dioxide	
Isopropyl Alcohol	Steel (Steel rebar)
Acrylic Bedding Sealant	Petroleum Based Automotive Fuel
Acrylic Resin/Toluene Solution	
Toluene	Diesel Fuel
Silicon Dioxide	
	Formaldehyde (used in Portable Toilet facilities)
Blue X Institutional Strength Cleaner	
2-Butoxyethanol	Sand
Ammonium Hydroxide	
Sweep Ez	<i>Note: also refer to on-site copies of any MSDS information.</i>
Dupont Oil Red B Liquid	

Storm Water Pollution Prevention Plan
For Espino Tract, 16-inch Offsite Water Line (Oversized)

Non-Stormwater Discharges

The following non-stormwater discharges from sites authorized under this general permit are also eligible for authorization under this general permit:

- Discharges from emergency firefighting activities (emergency firefighting activities do not include washing of trucks, run-off water from training activities, test water from fire suppression systems, or similar activities);
- Uncontaminated fire hydrant flushings (excluding discharges of hyperchlorinated water, unless the water is first dechlorinated and discharges are not expected to adversely affect aquatic life), which include flushings from systems that utilize potable water, surface water, or groundwater that does not contain additional pollutants (uncontaminated fire hydrant flushings do not include systems utilizing reclaimed wastewater as a source water); water from the routine external washing of vehicles, the external portion of buildings or structures, and pavement, where solvents, detergents, and soaps are not used, where spills or leaks of toxic or hazardous materials have not occurred (unless spilled materials have been removed; and if local state, or federal regulations are applicable, the materials are removed according to those regulations), and where the purpose is to remove mud, dirt, or dust;
- Uncontaminated water used to control dust;
- Potable water sources including waterline flushings, but excluding discharges of hyperchlorinated water, unless the water is first dechlorinated and discharges are not expected to adversely affect aquatic life;
- Uncontaminated air conditioning condensate;
- Uncontaminated groundwater or spring water, including foundation or footing drains where flows are not contaminated with industrial materials such as solvents;
- Lawn watering and similar irrigation drainage.

To prevent unauthorized non-stormwater discharges, all such discharges will be directed to sedimentation and erosion control structures prior to discharge. Attempts will be made to minimize such discharges to prevent contact with stormwater runoff.

Storm Water Pollution Prevention Plan
For Espino Tract, 16-inch Offsite Water Line (Oversized)

BMP Responsibility and Implementation

Non-structural and structural control measures and stabilization practices that will be implemented to prevent or control potential pollutants in stormwater discharges are summarized in the tables below. Each major activity will identify the appropriate control measure, general timing, (specific timing will be addressed in an attached construction schedule) and the responsible permittee for controlling the discharge.

Non-Structural Controls and Maintenance	Permittee Responsible	Schedule
Soil Disturbing Activities		
Areas are not to be disturbed until it is necessary for construction to proceed. Disturbed areas are to be covered and stabilized as soon as possible.	KB Home Lone Star, Inc. GENERAL CONTRACTOR TO BE DETERMINED	May 2025 - May 2028
Erosion and Sediment Controls		
Erosion/sediment controls will be designed to retain sediment on site to the extent practicable with consideration for site topography, soil type, and rainfall.	KB Home Lone Star, Inc. GENERAL CONTRACTOR TO BE DETERMINED	May 2025 - May 2028
Erosion/sediment controls will be designed and used to reduce the offsite transport of suspended sediments and other pollutants if dewatering activities are necessary.	KB Home Lone Star, Inc. GENERAL CONTRACTOR TO BE DETERMINED	May 2025 - May 2028

Storm Water Pollution Prevention Plan
For Espino Tract, 16-inch Offsite Water Line (Oversized)

Structural Controls and Maintenance	Permittee Responsible	Schedule
Erosion and Sediment Controls (continued)		
Erosion/sediment control measures will be in place prior to commencement of construction activities including clearing and grading. Disturbed areas will be restored as soon as practicable during construction. Temporary erosion and sedimentation controls will be removed only after all disturbed areas have been restored.	KB Home Lone Star, Inc. GENERAL CONTRACTOR TO BE DETERMINED	May 2025 - May 2028
Erosion/sediment controls such as silt fences, rock berms, outlet protection, and drainage channels are inspected weekly to ensure their effectiveness. Erosion and sediment control inspections are documented to ensure site compliance.	KB Home Lone Star, Inc. GENERAL CONTRACTOR TO BE DETERMINED	May 2025 - May 2028
Erosion/sediment controls are promptly maintained (as soon as practicable after damage is discovered, and prior to the next rain event, but no later than seven days after the inspections) to ensure maximum sediment removal from stormwater runoff.	KB Home Lone Star, Inc. GENERAL CONTRACTOR TO BE DETERMINED	May 2025 - May 2028
If sediment escapes the site, accumulations will be removed at a frequency to minimize negative effects and prior to the next rain event, if feasible.	KB Home Lone Star, Inc. GENERAL CONTRACTOR TO BE DETERMINED	May 2025 - May 2028
Sediment removed from erosion controls will be reused on site to minimize waste generation.	KB Home Lone Star, Inc. GENERAL CONTRACTOR TO BE DETERMINED	May 2025 - May 2028
Sediment deposited onto public right-of-way will be regularly removed to prevent sediment discharge from off site tracking during storm events, and reused on site whenever possible to prevent excess waste generation.	KB Home Lone Star, Inc. GENERAL CONTRACTOR TO BE DETERMINED	May 2025 - May 2028
Accumulated sediment will be removed when the depth reaches six inches (or 50% of the design capacity of site controls).	KB Home Lone Star, Inc. GENERAL CONTRACTOR TO BE DETERMINED	May 2025 - May 2028
Dust control will be provided by water trucks in such a manner that runoff does not occur.	KB Home Lone Star, Inc. GENERAL CONTRACTOR TO BE DETERMINED	May 2025 - May 2028

Storm Water Pollution Prevention Plan
For Espino Tract, 16-inch Offsite Water Line (Oversized)

Non-Structural Controls and Maintenance	Permittee Responsible	Schedule
Erosion and Sediment Controls (continued)		
<p>Disturbed areas including the construction storage and staging area and spoils disposal site where construction activity ceases for at least 14 days will be initiated immediately.</p> <p>Stabilization measures that provide a protective cover will be initiated immediately in portions of the site where construction activities have permanently ceased.</p>	<p>KB Home Lone Star, Inc. GENERAL CONTRACTOR TO BE DETERMINED</p>	<p>No temporary cessation of site construction is anticipated, but if so, May 2025 - May 2028</p>
<p>Mulching for temporary or final stabilization shall be accomplished by using shredded wood mulch. To avoid waste generation, trees cut down on site will be recycled into mulch for stabilization.</p>	<p>KB Home Lone Star, Inc. GENERAL CONTRACTOR TO BE DETERMINED</p>	<p>May 2025 - May 2028</p>
<p>Seeding for temporary or final stabilization shall be accomplished by broadcast seeding, sodding, or hydromulch application.</p>	<p>KB Home Lone Star, Inc. GENERAL CONTRACTOR TO BE DETERMINED</p>	<p>May 2025 - May 2028</p>
<p>Irrigation for temporary or final stabilization will be achieved by sprinkling in a manner that will not erode the topsoil but will sufficiently soak the soil to a depth of six inches. The irrigation may occur at 10-day intervals during the first two months. Rainfall occurrences of 0.5 inch or more should postpone the watering schedule for one week.</p>	<p>KB Home Lone Star, Inc. GENERAL CONTRACTOR TO BE DETERMINED</p>	<p>May 2025 - May 2028</p>

Storm Water Pollution Prevention Plan
For Espino Tract, 16-inch Offsite Water Line (Oversized)

Non-Structural Controls and Maintenance	Permittee Responsible	Schedule
Material Storage, Handling, and Disposal		
Construction materials will be stored in the construction staging and materials storage area. An attempt will be made to store materials inside or under cover as practicable to minimize contact of stormwater with potential pollutants and prevent water damage to materials.	KB Home Lone Star, Inc. GENERAL CONTRACTOR TO BE DETERMINED	May 2025 - May 2028
Excess spoils will be temporarily stored away from drainage channels/creeks and ponds, preferably out of floodplains to prevent offsite discharge.	KB Home Lone Star, Inc. GENERAL CONTRACTOR TO BE DETERMINED	May 2025 - May 2028
An effort will be made to store only enough products required to do the job to minimize waste generation and potential contact with stormwater.	KB Home Lone Star, Inc. GENERAL CONTRACTOR TO BE DETERMINED	May 2025 - May 2028
Lubricants will not routinely be stored on site, except the small amount needed for a specific process or piece of equipment.	KB Home Lone Star, Inc. GENERAL CONTRACTOR TO BE DETERMINED	May 2025 - May 2028
Materials will be used according to the manufacturer's recommendation for proper use and disposal.	KB Home Lone Star, Inc. GENERAL CONTRACTOR TO BE DETERMINED	May 2025 - May 2028
Chemicals will be stored in their original containers (unless they are not resealable), with the labels intact for proper identification.	KB Home Lone Star, Inc. GENERAL CONTRACTOR TO BE DETERMINED	May 2025 - May 2028
Material Safety Data Sheets and original labels for products used or stored at the site will be retained as they contain important storage, handling, and disposal information.	KB Home Lone Star, Inc. GENERAL CONTRACTOR TO BE DETERMINED	May 2025 - May 2028
During landscaping, fertilizers and pesticides will not be applied just before or during a storm event. Such landscape chemicals will be applied in the minimum amount recommended by the manufacturer. Fertilizers will be worked into the soil to minimize contact with stormwater.	KB Home Lone Star, Inc. GENERAL CONTRACTOR TO BE DETERMINED	May 2025 - May 2028

Storm Water Pollution Prevention Plan
For Espino Tract, 16-inch Offsite Water Line (Oversized)

If disposal is necessary for excess product, the manufacturer's recommendations or local or state regulations for proper disposal will be followed.	KB Home Lone Star, Inc. GENERAL CONTRACTOR TO BE DETERMINED	May 2025 - May 2028
---	---	------------------------

Storm Water Pollution Prevention Plan
For Espino Tract, 16-inch Offsite Water Line (Oversized)

Non-Structural Controls and Maintenance	Permittee Responsible	Schedule
Waste Storage, Handling, and Disposal		
Portable toilet facilities serviced by a licensed disposal company are available on the site to ensure proper disposal of wastes.	KB Home Lone Star, Inc. GENERAL CONTRACTOR TO BE DETERMINED	Weekly
<p>Non-stormwater discharges such as from concrete truck wash outs, surplus concrete or drum water will be limited to the designated concrete washout areas. Designated concrete washout areas are recommended to be:</p> <ul style="list-style-type: none"> ● at least 15 feet from the curb ● excavated below grade for pit area ● lined with a poly-liner ● have a large stabilized entrance ● have sufficient perimeter BMP's <p>They will be maintained as needed to contain concrete rinse water and minimize offsite discharges and to prevent potential discharge to stormwater runoff. Upon construction completion, the designated concrete washout areas will be cleaned up in accordance with applicable regulations.</p>	KB Home Lone Star, Inc. GENERAL CONTRACTOR TO BE DETERMINED	May 2025 - May 2028
Waste generation will be minimized by purchasing only the amount of material estimated as necessary for the application, and where practicable, using all of a product prior to disposal of the container.	KB Home Lone Star, Inc. GENERAL CONTRACTOR TO BE DETERMINED	May 2025 - May 2028
The site will be routinely patrolled for regular trash and debris collection. Once collected, the waste will be stored as described below.	KB Home Lone Star, Inc. GENERAL CONTRACTOR TO BE DETERMINED	May 2025 - May 2028
Waste materials will be collected and stored in metal dumpsters meeting state and local waste management requirements. When full, the dumpsters will be emptied and the trash hauled to an approved offsite dump. No construction waste materials will be buried on site.	KB Home Lone Star, Inc. GENERAL CONTRACTOR TO BE DETERMINED	May 2025 - May 2028
Non-hazardous, latex paint wastes (i.e. wash water) will be disposed of in accordance with applicable regulations.	KB Home Lone Star, Inc. GENERAL CONTRACTOR TO BE DETERMINED	May 2025 - May 2028
Potentially hazardous and/or liquid wastes generated on site will be stored under cover, in leak proof containers to await proper disposal by	KB Home Lone Star, Inc.	May 2025 -

Storm Water Pollution Prevention Plan
For Espino Tract, 16-inch Offsite Water Line (Oversized)

licensed disposal companies.	GENERAL CONTRACTOR TO BE DETERMINED	May 2028
------------------------------	--	----------

Storm Water Pollution Prevention Plan
For Espino Tract, 16-inch Offsite Water Line (Oversized)

Non-Structural Controls and Maintenance	Permittee Responsible	Schedule
Spill Prevention and Response		
Spill cleanup materials will be stored on site in the material storage area, and may include: brooms, dustpans, mops, rags, gloves, goggles, sawdust or other absorbent material, plastic/metal trash containers specifically for this purpose.	KB Home Lone Star, Inc. GENERAL CONTRACTOR TO BE DETERMINED	May 2025 - May 2028
Site personnel will be made aware of spill clean up procedures and location of spill cleanup materials.	KB Home Lone Star, Inc. GENERAL CONTRACTOR TO BE DETERMINED	May 2025 - May 2028
Spills will be cleaned up upon discovery following the procedure outlined in Section V.	KB Home Lone Star, Inc. GENERAL CONTRACTOR TO BE DETERMINED	May 2025 - May 2028
Storage of vehicles and equipment on site will be limited to minimize potential for leaks or spills to contaminated stormwater runoff.	KB Home Lone Star, Inc. GENERAL CONTRACTOR TO BE DETERMINED	May 2025 - May 2028
Where possible, vehicles and equipment will be stored over an impervious surface, away from stormwater conveyances, to facilitate clean up of potential leaks or spills and prevent contact with stormwater.	KB Home Lone Star, Inc. GENERAL CONTRACTOR TO BE DETERMINED	May 2025 - May 2028
Vehicles and equipment used on site will be monitored and maintained to prevent leaks from occurring.	KB Home Lone Star, Inc. GENERAL CONTRACTOR TO BE DETERMINED	May 2025 - May 2028

Storm Water Pollution Prevention Plan
For Espino Tract, 16-inch Offsite Water Line (Oversized)

BMP Specifications

Interim Structural Controls	Schedule of Implementation	Location	Reason
Silt fence	Prior to and throughout site development	Refer to the civil plans and site maps	Silt fence will be constructed at the downstream edge of disturbed areas where there will be shallow sheet flow to slow the flow of stormwater runoff and promote sediment deposition.
Socks / wattles	N/A	N/A	Socks/wattles will not be used due to the use of alternative stormwater treatment devices.
Stabilized Construction Entrance/Exit	Prior to and throughout site development	Refer to the civil plans and site maps	Construction entrances/exits consisting of 3"-5" dump rock will be placed on the site to minimize off site tracking of sediment by vehicles.
Designated concrete washout	Throughout site development	Refer to the civil plans and site maps	A designated concrete washout will be used to prevent discharge of washout material into the storm drains or water bodies.
Earth dikes (diversion berms)	N/A	N/A	Earthen dikes (diversion berms) will not be used due to the use of alternative stormwater treatment devices.
Sediment Traps	N/A	N/A	Sediment traps will not be used due to the considerable maintenance necessary to remove accumulated sediment and prevent street flooding both during and after construction.
Check Dams	Throughout site development	Refer to the civil plans and site maps	Rock berms will be installed to slow the flow of stormwater runoff and to promote sediment deposition.
Storm drain inlet protection (existing inlets)	N/A	N/A	Inlet protection will not be used due to the use of alternative stormwater treatment devices.
Storm drain inlet	N/A	N/A	Inlet protection will not be used

Storm Water Pollution Prevention Plan
For Espino Tract, 16-inch Offsite Water Line (Oversized)

protection (proposed inlets)			due to the use of alternative stormwater treatment devices.
Temporary basins	N/A	N/A	No temporary basins were required for the site due to the proposed site conditions and controls.

Storm Water Pollution Prevention Plan
For Espino Tract, 16-inch Offsite Water Line (Oversized)

Permanent Structural Controls

Measures that will be installed during construction process to control pollutants in stormwater discharges that will occur after construction operations have been completed.

Stormwater Management Measures	Schedule of Implementation	Location	Reason
Drainage Swales	Throughout site development	Refer to the civil plans and site maps	Proposed drainage easements/channels will be used to convey stormwater runoff into the storm sewer system or offsite thereby slowing the flow of stormwater runoff and promoting sediment deposition.
Velocity/energy dissipation devices/rip rap	Throughout site development	Refer to the civil plans and site maps	Velocity/energy dissipation devices and/or rip rap will be used to prevent erosion around the stormwater outfalls/outlets.
Level Spreaders	N/A	N/A	Level spreaders will not be used due to the use of alternative stormwater treatment devices.
Gabions	N/A	N/A	Gabions will not be used due to the use of alternative stormwater treatment devices.
Stormwater Detention Structures	N/A	N/A	No permanent detention basins were required due to the drainage areas being less than 10 acres.
Stormwater Retention Structures	N/A	N/A	No permanent retention basins were required for the site due to the proposed site conditions and controls.
Stormwater Bio-Infiltration Structures	N/A	N/A	No permanent bio-infiltration basins were required for the site due to the proposed site conditions and controls.

16-inch Offsite Water Line (Oversized):

A sedimentation basin will not be constructed with this project due to limited space within water easements.

These equivalent control measures will be used until final stabilization: silt fence and rock berms.

Storm Water Pollution Prevention Plan
For Espino Tract, 16-inch Offsite Water Line (Oversized)

Interim Stabilization Practices	Schedule of Implementation	Location	Reason
Temporary vegetation / mulching	Throughout site development	Various areas throughout the site	Stabilization of disturbed areas must, at a minimum, be initiated immediately whenever any clearing, grading, excavating, or other earth disturbing activities have temporarily ceased on any portion of the site and will not resume for a period exceeding 14 calendar days.
Rolled erosion control products (geotextiles)	Throughout site development	As needed at various locations throughout the site	Rolled erosion control products (geotextiles) will be used as an interim practice to prevent topsoil loss and erosion.
Protection of trees	Prior to and throughout site development	As needed at various locations throughout the site	Tree protection will be used to prevent damage to this valuable natural resource.

Storm Water Pollution Prevention Plan
For Espino Tract, 16-inch Offsite Water Line (Oversized)

Permanent Stabilization Practices	Schedule of Implementation	Location	Reason
Permanent vegetation / mulching	During site landscaping	At various landscaped areas throughout the site	Permanent vegetation (hydromulching or sod stabilization) / mulching will be used to quickly establish vegetative cover to prevent erosion. Additional considerations were infiltration and improvement of storm water quality.
Vegetative buffer strips	N/A	N/A	No permanent vegetative buffer strips are planned for this site.
Preservation of mature vegetation	N/A	N/A	As little, if any, desirable mature vegetation exists on site; no preservation of mature vegetation is expected.

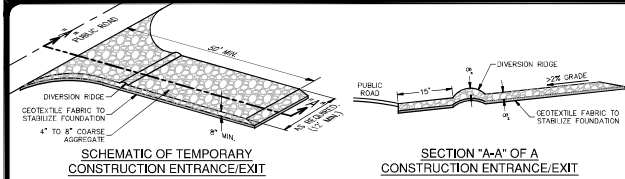

- MATERIALS**
1. THE AGGREGATE SHOULD CONSIST OF 4-INCH TO 8-INCH WASHED STONE OVER A STABLE FOUNDATION AS SHOWN IN THE PLAN.
 2. THE AGGREGATE SHOULD BE PLACED WITH A MINIMUM THICKNESS OF 8-INCHES.
 3. THE GEOTEXTILE FABRIC SHOULD BE DESIGNED SPECIFICALLY FOR USE AS A SOIL FILTRATION MEDIA WITH AN APPROXIMATE HEIGHT OF 45 OZ/SY, A MULLIN BURST RATING OF 140 LB/IN, AND AN EQUIVALENT OPENING SIZE GREATER THAN A NUMBER 50 SIEVE.
 4. IF A WASHING FACILITY IS REQUIRED, A LEVEL AREA WITH A MINIMUM OF 4-INCH DIAMETER WASHED STONE OR COMMERCIAL ROCK SHOULD BE INCLUDED IN THE PLANS. DIVERT WASTEWATER TO A SEDIMENT TRAP OR BASIN.
- INSTALLATION**
1. ADD CURB OR PUBLIC ROAD AND STEP SLOPES REMOVE VEGETATION AND OTHER OBJECTIONABLE MATERIAL FROM THE FOUNDATION AREA. GRADE DOWN FOUNDATION FOR POSITIVE DRAINAGE.
 2. THE MINIMUM WIDTH OF THE ENTRANCE/EXIT SHOULD BE 12 FEET OR THE FULL WIDTH OF EXT ROADWAY, WHICHEVER IS GREATER.
 3. THE CONSTRUCTION ENTRANCE SHOULD BE AT LEAST 50 FEET LONG.
 4. IF THE SLOPE TOWARD THE ROAD EXCEEDS 2% CONTACT A RIDE, 4-INCHES TO 8-INCHES HIGH WITH AT LEAST ONE SIDE. ACROSS THE FOUNDATION APPROXIMATELY 15 FEET FROM THE ENTRANCE TO DIVERT RUNOFF AWAY FROM THE PUBLIC ROAD.
 5. PLACE GEOTEXTILE FABRIC AND GRADE FOUNDATION TO IMPROVE STABILITY, ESPECIALLY WHERE WET CONDITIONS ARE ANTICIPATED.
 6. PLACE STONE TO DIMENSIONS AND GRADE SHOWN ON PLANS. LEAVE SURFACE SMOOTH AND SLOPE FOR DRAINAGE.
 7. DIVERT ALL SURFACE RUNOFF AND DRAINAGE FROM THE STONE PAD TO A SEDIMENT TRAP OR BASIN.
 8. INSTALL PIPE UNDER PAD AS NEEDED TO MAINTAIN PROPER PUBLIC ROAD DRAINAGE.

STABILIZED CONSTRUCTION ENTRANCE/EXIT DETAIL

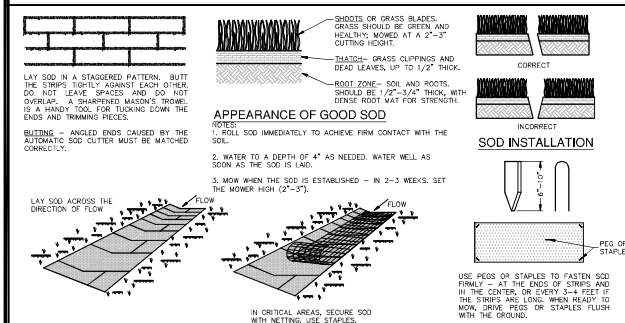

- MATERIALS**
1. SOD SHOULD BE MACHINE CUT AT A UNIFORM SOIL THICKNESS OF 3/4" INCH (3/4" HIGH) AT THE TIME OF CUTTING. THIS THICKNESS SHOULD INCLUDE SHOOT GROWTH AND THATCH.
 2. PIECES OF SOD SHOULD BE CUT TO THE SUPPLIER'S STANDARD WIDTH AND LENGTH, WITH A MAXIMUM ALLOWABLE VARIATION IN ANY DIMENSION OF SIX TORN OR UNEVEN PADS SHOULD NOT BE ACCEPTABLE.
 3. STANDARD SIZE SECTIONS OF SOD SHOULD BE STRONG ENOUGH TO SURVIVE THEIR OWN WEIGHT AND RETAIN THEIR SIZE AND SHAPE WHEN SUSPENDED FROM A FIRM GRASP ON ONE END OF THE SECTION.
 4. SOD SHOULD BE HARVESTED, DELIVERED, AND INSTALLED WITHIN A PERIOD OF 36 HOURS.
- INSTALLATION IN CHANNELS**
1. SOD STRIPS IN WATERWAYS SHOULD BE LAID PERPENDICULAR TO THE DIRECTION OF FLOW. CARE SHOULD BE TAKEN TO BUTT ENDS OF STRIPS TIGHTLY (SEE FIGURE ABOVE).
 2. AFTER ROLLING OR TAMPING, SOD SHOULD BE PROPPED OR STAPLED TO PREVENT WASHING AWAY DURING THE ESTABLISHMENT PERIOD. NEW OR USED NETTING MAY BE PEGGED OVER THE SOD FOR EXTRA PROTECTION IN CRITICAL AREAS.
- GENERAL INSTALLATION (VA. DEPT. OF CONSERVATION, 1992)**
1. SOD SHOULD NOT BE CUT OR LAID IN EXCESSIVELY WET OR DRY WEATHER. SOD ALSO SHOULD NOT BE LAID ON SOIL SURFACES THAT ARE FROZEN.
 2. DURING PERIODS OF HIGH TEMPERATURE, THE SOIL SHOULD BE LIGHTLY BROADCAST IMMEDIATELY PRIOR TO LAYING THE SOD, TO COOL THE SOIL AND REDUCE ROOT BURNING AND DISEASE.
 3. THE FIRST ROW OF SOD SHOULD BE Laid IN A STRAIGHT LINE WITH SUBSEQUENT ROWS PLACED PARALLEL TO AND TIGHTLY ADJACENT EACH OTHER. LATERAL JOINTS SHOULD BE STaggerED TO PROMOTE MORE UNIFORM GROWTH AND PREVENT CARE SHOULD BE EXERCISED TO ENSURE THAT SOD IS NOT STRETCHED OR OVERLAPPED AND THAT ALL JOINTS ARE BUTTED TIGHT (SEE FIGURE ABOVE).
 4. SOIL SURFACES THAT ARE HEAVILY BAKED OR BARE SHOULD BE TREATED WITH SEED OR INERTIVE MATERIALS.
 5. AS SOON AS CLEARLY BAKED AREAS ARE COMPACTED, SOD SHOULD BE ROLLED OR TAMPED TO PROVIDE FIRM CONTACT BETWEEN ROWS AND SOIL.
 6. AFTER ROLLING, SOD SHOULD BE IRRIGATED TO A DEPTH SUFFICIENT TO SATURATE THE ENTIRE SOIL PROFILE TO A DEPTH OF 4 INCHES UNDER THE SOD IS THOROUGHLY WET.
 7. UNTIL SUCH TIME A GOOD ROOT SYSTEM BECOMES DEVELOPED, IN THE APPROXIMATE OF 10 TO 15 DAYS, SOD SHOULD BE IRRIGATED AS OFTEN AS NECESSARY TO MAINTAIN MOST SOIL TO A DEPTH OF AT LEAST 4 INCHES.
 8. THE FIRST MOWING SHOULD NOT BE ATTEMPTED UNTIL THE SOD IS FIRMLY ROOTED, USUALLY 2-3 WEEKS. NOT MORE THAN ONE THIRD OF THE GRASS LEAF SHOULD BE REMOVED AT ANY ONE CUTTING.

- INSPECTION AND MAINTENANCE GUIDELINES**
1. SOD SHOULD BE INSPECTED WEEKLY AND AFTER EACH RAIN EVENT TO LOCATE AND REPAIR ANY DAMAGE.
 2. DAMAGE FROM CHURNS OR NORMAL CONSTRUCTION ACTIVITIES SUCH AS RITS OR OBSTRUCTION OF SMALL STABILIZATION SHOULD BE REPAIRED AS SOON AS PRACTICAL.

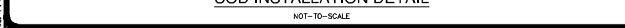

NOT-TO-SCALE

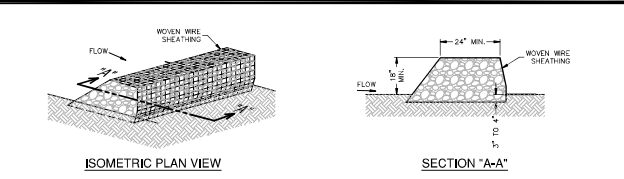

- ROCK BERMS**
- THE PURPOSE OF A ROCK BERM IS TO SERVE AS A CHECK DAM IN AREAS OF CONCENTRATED FLOW, TO INTERCEPT SEDIMENT-LOADED RUNOFF, DETAIN THE SEDIMENT AND RELEASE THE WATER IN SHEET FLOW. THE ROCK BERM SHOULD BE USED WHEN THE CONTRIBUTING DRAINAGE AREA IS LESS THAN 5 ACRES. ROCK BERMS ARE USED IN AREAS WHERE THE VOLUME OF RUNOFF IS TOO GREAT FOR A SILT FENCE TO CONTAIN. THEY ARE LESS EFFECTIVE FOR SEDIMENT REMOVAL THAN SILT FENCES, PARTICULARLY FOR FINE PARTICLES, BUT ARE ABLE TO WITHSTAND HIGHER FLOWS THAN A SILT FENCE. AS SUCH, ROCK BERMS ARE OFTEN USED IN AREAS OF CHANNEL FLOWS (DITCHES, GULLIES, ETC.). ROCK BERMS ARE MOST EFFECTIVE AT REDUCING BED LOAD IN CHANNELS AND SHOULD NOT BE SUBSTITUTED FOR OTHER EROSION AND SEDIMENT CONTROL MEASURES FURTHER UP THE WATERSHED.
- MATERIALS**
1. THE BERM STRUCTURE SHOULD BE SECURED WITH A WOVEN WIRE MESH HAVING MAXIMUM OPENINGS OF 1 INCH AND A MINIMUM WIRE DIAMETER OF 20 GAUGE GALVANIZED AND SHOULD BE SECURED WITH SHIRT RINGS.
 2. CLEAN, DRY, ROUND 3-INCH TO 5-INCH DIAMETER ROCK SHOULD BE USED, EXCEPT IN AREAS WHERE HIGH VELOCITIES OR LARGE VOLUMES OF FLOW ARE EXPECTED, WHERE 5-INCH TO 8-INCH DIAMETER ROCKS MAY BE USED.
- INSTALLATION**
1. LAY OUT THE WOVEN WIRE SHEATHING PERPENDICULAR TO THE FLOW LINE. THE SHEATHING SHOULD BE 20 GAUGE WOVEN WIRE MESH WITH 1 INCH OPENINGS.
 2. BERM SHOULD HAVE A TOP WIDTH OF 2 FEET MINIMUM WITH SIDE SLOPES BEING 2:1 (H:V) OR FLATTER.
 3. PLACE THE ROCK ALONG THE SHEATHING AS SHOWN IN THE DIAGRAM TO A HEIGHT NOT LESS THAN 18".
 4. WRAP THE WIRE SHEATHING AROUND THE ROCK AND SECURE WITH THE WIRE SO THAT THE ENDS OF THE SHEATHING OVERLAP AT LEAST 2 INCHES, AND THE BERM RETAINS ITS SHAPE WHEN WAGED UPON.
 5. BERM SHOULD BE BUILT ALONG THE CONTOUR AT ZERO PERCENT GRADE OR AS NEAR AS POSSIBLE.
 6. THE ENDS OF THE BERM SHOULD BE TIED INTO EXISTING UNSLOPED GRADE AND THE BERM SHOULD BE BURED IN A TRENCH APPROXIMATELY 3 TO 4 INCHES DEEP TO PREVENT FLOWING OF THE CONTOUR.
- COMMON TROUBLE POINTS**
1. INSUFFICIENT BERM HEIGHT OR LENGTH RUNOFF QUICKLY ESCAPES OVER THE TOP OR AROUND THE SIDES OF BERM.
 2. BERM NOT INSTALLED PERPENDICULAR TO FLOW LINE (RUNOFF ESCAPING AROUND ONE SIDE).
- INSPECTION AND MAINTENANCE GUIDELINES**
1. INSPECTION SHOULD BE MADE WEEKLY AND AFTER EACH RAINFALL BY THE RESPONSIBLE PARTY. ROW INSTALLATIONS IN STREAMBEDS, ADDITIONAL DAILY INSPECTIONS SHOULD BE MADE.
 2. REMOVE SEDIMENT AND OTHER DEBRIS WHEN BUILDUP REACHES 6 INCHES AND DISPOSE OF THE ACCUMULATED SLT IN AN APPROVED MANNER THAT WILL NOT CAUSE ANY ADDITIONAL EROSION.
 3. REPAIR ANY LOSS OF WIRE SHEATHING.
 4. THE BERM SHOULD BE RESHAPED AS NEEDED DURING INSPECTION.
 5. THE BERM SHOULD BE REPLACED WHEN THE STRUCTURE CEASES TO FUNCTION AS INTENDED DUE TO SILT ACCUMULATION AROUND THE ROCKS, WASHOUT, CONSTRUCTION TRAFFIC DAMAGE, ETC.
 6. THE ROCK BERM SHOULD BE LEFT IN PLACE UNTIL ALL UPSTREAM AREAS ARE STABILIZED AND ACCUMULATED SILT REMOVED.

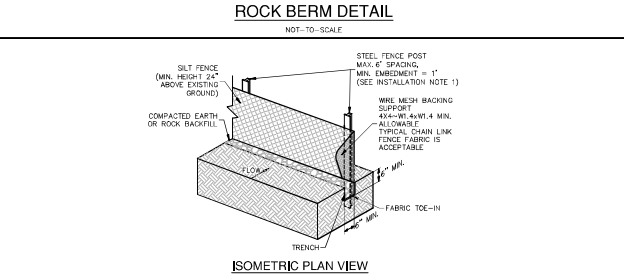

- GENERAL INSTALLATION (VA. DEPT. OF CONSERVATION, 1992)**
1. SOD SHOULD NOT BE CUT OR LAID IN EXCESSIVELY WET OR DRY WEATHER. SOD ALSO SHOULD NOT BE LAID ON SOIL SURFACES THAT ARE FROZEN.
 2. DURING PERIODS OF HIGH TEMPERATURE, THE SOIL SHOULD BE LIGHTLY BROADCAST IMMEDIATELY PRIOR TO LAYING THE SOD, TO COOL THE SOIL AND REDUCE ROOT BURNING AND DISEASE.
 3. THE FIRST ROW OF SOD SHOULD BE Laid IN A STRAIGHT LINE WITH SUBSEQUENT ROWS PLACED PARALLEL TO AND TIGHTLY ADJACENT EACH OTHER. LATERAL JOINTS SHOULD BE STaggerED TO PROMOTE MORE UNIFORM GROWTH AND PREVENT CARE SHOULD BE EXERCISED TO ENSURE THAT SOD IS NOT STRETCHED OR OVERLAPPED AND THAT ALL JOINTS ARE BUTTED TIGHT (SEE FIGURE ABOVE).
 4. SOIL SURFACES THAT ARE HEAVILY BAKED OR BARE SHOULD BE TREATED WITH SEED OR INERTIVE MATERIALS.
 5. AS SOON AS CLEARLY BAKED AREAS ARE COMPACTED, SOD SHOULD BE ROLLED OR TAMPED TO PROVIDE FIRM CONTACT BETWEEN ROWS AND SOIL.
 6. AFTER ROLLING, SOD SHOULD BE IRRIGATED TO A DEPTH SUFFICIENT TO SATURATE THE ENTIRE SOIL PROFILE TO A DEPTH OF 4 INCHES UNDER THE SOD IS THOROUGHLY WET.
 7. UNTIL SUCH TIME A GOOD ROOT SYSTEM BECOMES DEVELOPED, IN THE APPROXIMATE OF 10 TO 15 DAYS, SOD SHOULD BE IRRIGATED AS OFTEN AS NECESSARY TO MAINTAIN MOST SOIL TO A DEPTH OF AT LEAST 4 INCHES.
 8. THE FIRST MOWING SHOULD NOT BE ATTEMPTED UNTIL THE SOD IS FIRMLY ROOTED, USUALLY 2-3 WEEKS. NOT MORE THAN ONE THIRD OF THE GRASS LEAF SHOULD BE REMOVED AT ANY ONE CUTTING.
- INSPECTION AND MAINTENANCE GUIDELINES**
1. SOD SHOULD BE INSPECTED WEEKLY AND AFTER EACH RAIN EVENT TO LOCATE AND REPAIR ANY DAMAGE.
 2. DAMAGE FROM CHURNS OR NORMAL CONSTRUCTION ACTIVITIES SUCH AS RITS OR OBSTRUCTION OF SMALL STABILIZATION SHOULD BE REPAIRED AS SOON AS PRACTICAL.

- CONCRETE TRUCK WASHOUT**
- PIT DETAIL**
- NOT-TO-SCALE**

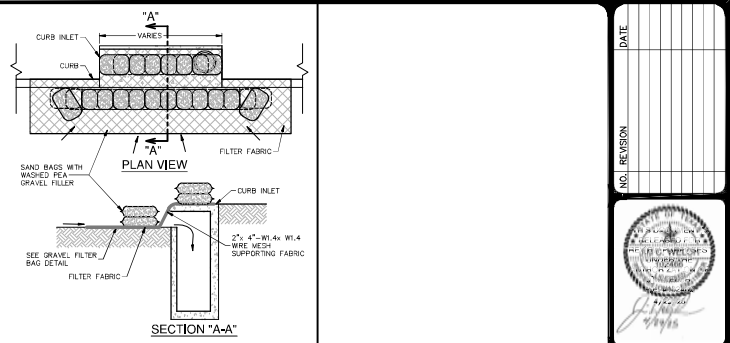

- GENERAL NOTES**
1. CONTRACTOR TO INSTALL 2"x4"-W/4x4 WIRE MESH SUPPORTING FILTER FABRIC OVER THE INLET OPENING. FABRIC MUST BE SECURED TO WIRE WITH RINGS OR WIRE TIES AT THIS LOCATION. SAND BAGS FILLED WITH WASHED PEA GRAVEL SHOULD BE PLACED ON TOP OF WIRE MESH ON TOP OF THE INLET AS SHOWN ON THIS DETAIL TO HOLD WIRE MESH IN PLACE. SAND BAGS FILLED WITH WASHED PEA GRAVEL SHOULD ALSO BE PLACED ALONG THE OUTER AS SHOWN ON THIS DETAIL TO HOLD WIRE MESH IN PLACE. SAND BAGS TO BE STACKED TO FORM A CONTINUOUS BARRIER AROUND INLETS.
 2. THE BAGS SHOULD BE TIGHTLY ADJUTED AGAINST EACH OTHER TO PREVENT RUNOFF FROM FLOWING BETWEEN THE BAGS.
- INSPECTION AND MAINTENANCE GUIDELINES**
1. INSPECTION SHOULD BE MADE WEEKLY AND AFTER EACH RAINFALL. REPAIR OR IMPROVEMENT SHOULD BE MADE PROMPTLY AS NEEDED BY THE CONTRACTOR.
 2. REMOVE SEDIMENT WHEN BUILDUP REACHES A DEPTH OF 3 INCHES. REMOVED SEDIMENT SHOULD BE DEPOSITED IN A SUITABLE AREA AND IN SUCH A MANNER THAT IT WILL NOT ERODE.
 3. CHECK PLACEMENT OF DEVICE TO PREVENT GAPS BETWEEN DEVICE AND CURB.
 4. INSPECT FILTER FABRIC AND PATCH OR REPLACE IF TORN OR MISSING.
 5. STRUCTURES SHOULD BE REMOVED AND THE AREA STABILIZED ONLY AFTER THE REMAINING DRAINAGE AREA HAS BEEN PROPERLY STABILIZED.

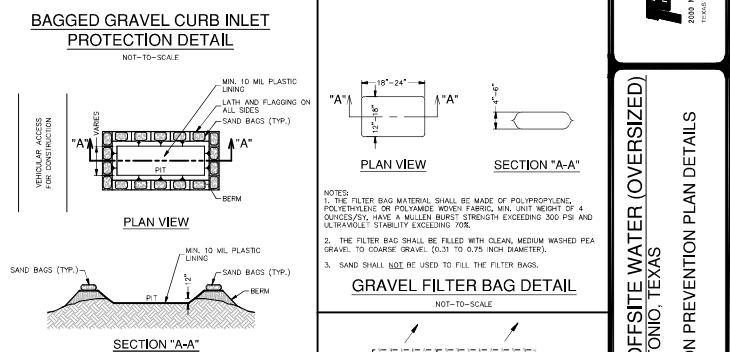

- GENERAL NOTES**
1. DETAIL ABOVE ILLUSTRATES MINIMUM DIMENSIONS. PIT CAN BE INCREASED IN SIZE DEPENDING ON EXPECTED FREQUENCY OF USE.
 2. WASHOUT PIT SHOULD BE LOCATED IN AN AREA EASILY ACCESSIBLE TO CONSTRUCTION TRAFFIC.
 3. WASHOUT PIT SHALL NOT BE LOCATED IN AREAS SUBJECT TO INUNDATION FROM STORM WATER RUNOFF.
 4. LOCATE WASHOUT AREA AT LEAST 50 FEET FROM SENSITIVE FEATURES, STORM DRAINS, OPEN DITCHES OR WATER BODIES.
 5. TEMPORARY CONCRETE WASHOUT FACILITY SHOULD BE CONSTRUCTED WITH SUFFICIENT QUANTITY AND VOLUME TO CONTAIN ALL LIQUID AND CONCRETE WASTE GENERATED BY WASHOUT OPERATIONS.
- MATERIALS**
- PLASTIC LINING MATERIAL SHOULD BE A MINIMUM OF 10 MIL IN POLYETHYLENE SHEETING AND SHOULD BE FREE OF HOLE, TEARS, OR OTHER DEFECTS THAT COMPROMISE THE IMPERMEABILITY OF THE MATERIAL.
- MAINTENANCE**
1. WHEN TEMPORARY CONCRETE WASHOUT FACILITIES ARE NO LONGER REQUIRED FOR THE WORK, THE HARDENED CONCRETE SHOULD BE REMOVED AND DISPOSER OF.
 2. MATERIALS USED TO CONSTRUCT TEMPORARY CONCRETE WASHOUT FACILITIES SHOULD BE REMOVED FROM THE SITE OF THE WORK AND DISPOSER OF.
- CONCRETE TRUCK WASHOUT**
- PIT DETAIL**
- NOT-TO-SCALE**

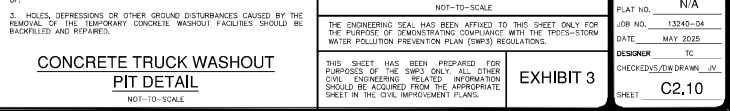

NOT-TO-SCALE

DATE: Apr. 28, 2024
 DRAWN BY: Pape-Dawson Engineers
 CHECKED BY: Pape-Dawson Engineers
 PROJECT NO.: 240000000

NO. / REVISION

NO.	REVISION

DATE: _____

ESPINO TRACT 16-INCH OFFSITE WATER (OVERSIZED) SAN ANTONIO, TEXAS

PLAT NO. N/A
 JOB NO. 13240-04
 DATE: MAY 2025
 DESIGNER: TC
 CHECKED BY: @DRAWN_BY

EXHIBIT 3

C2.10

THIS SHEET HAS BEEN PREPARED FOR THE PURPOSES OF THE SWQ ONLY. ALL OTHER CIVIL ENGINEERING RELATED INFORMATION SHOULD BE ACQUIRED FROM THE APPROPRIATE SHEET IN THE CIVIL IMPROVEMENT PLAN.

THE ENGINEERING SEAL HAS BEEN AFFIXED TO THIS SHEET ONLY FOR THE PURPOSE OF DEMONSTRATING COMPLIANCE WITH THE TDES-STORM WATER POLLUTION PREVENTION PLAN (SWP3) REGULATIONS.

THIS SHEET HAS BEEN PREPARED FOR THE PURPOSES OF THE SWQ ONLY. ALL OTHER CIVIL ENGINEERING RELATED INFORMATION SHOULD BE ACQUIRED FROM THE APPROPRIATE SHEET IN THE CIVIL IMPROVEMENT PLAN.

THIS SHEET HAS BEEN PREPARED FOR THE PURPOSES OF THE SWQ ONLY. ALL OTHER CIVIL ENGINEERING RELATED INFORMATION SHOULD BE ACQUIRED FROM THE APPROPRIATE SHEET IN THE CIVIL IMPROVEMENT PLAN.

THIS SHEET HAS BEEN PREPARED FOR THE PURPOSES OF THE SWQ ONLY. ALL OTHER CIVIL ENGINEERING RELATED INFORMATION SHOULD BE ACQUIRED FROM THE APPROPRIATE SHEET IN THE CIVIL IMPROVEMENT PLAN.

Storm Water Pollution Prevention Plan
For Espino Tract, 16-inch Offsite Water Line (Oversized)

1.4.18 Concrete Washout Areas

The purpose of concrete washout areas is to prevent or reduce the discharge of pollutants to stormwater from concrete waste by conducting washout offsite, performing onsite washout in a designated area, and training employees and subcontractors.

The following steps will help reduce stormwater pollution from concrete wastes:

- Incorporate requirements for concrete waste management into material supplier and subcontractor agreements.
- Avoid mixing excess amounts of fresh concrete.
- Perform washout of concrete trucks in designated areas only.
- Do not wash out concrete trucks into storm drains, open ditches, streets, or streams.
- Do not allow excess concrete to be dumped onsite, except in designated areas.

For onsite washout:

- Locate washout area at least 50 feet from sensitive features, storm drains, open ditches, or water bodies. Do not allow runoff from this area by constructing a temporary pit or bermed area large enough for liquid and solid waste.
- Wash out wastes into the temporary pit where the concrete can set, be broken up, and then disposed properly.

Below grade concrete washout facilities are typical. These consist of a lined excavation sufficiently large to hold expected volume of washout material. Above grade facilities are used if excavation is not practical. Temporary concrete washout facility (type above grade) should be constructed as shown on the details at the end of this section, with sufficient quantity and volume to contain all liquid and concrete waste generated by washout operations. Plastic lining material should be a minimum of 10 mil in polyethylene sheeting and should be free of holes, tears, or other defects that compromise the impermeability of the material.

When temporary concrete washout facilities are no longer required for the work, the hardened concrete should be removed and disposed of. Materials used to construct temporary concrete washout facilities should be removed from the site of the work and disposed of. Holes, depressions or other ground disturbance caused by the removal of the temporary concrete washout facilities should be backfilled and repaired.

Storm Water Pollution Prevention Plan
 For Espino Tract, 16-inch Offsite Water Line (Oversized)

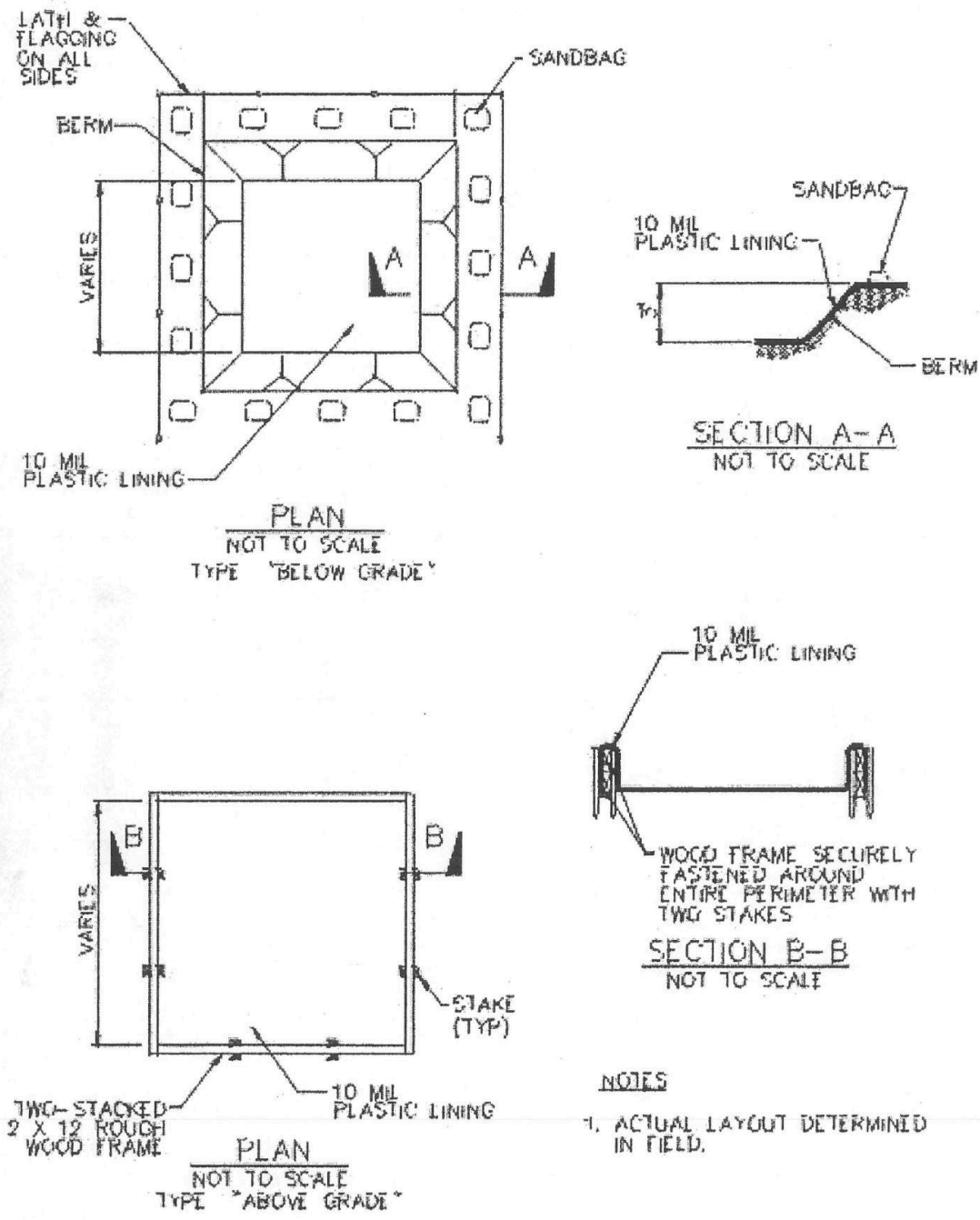
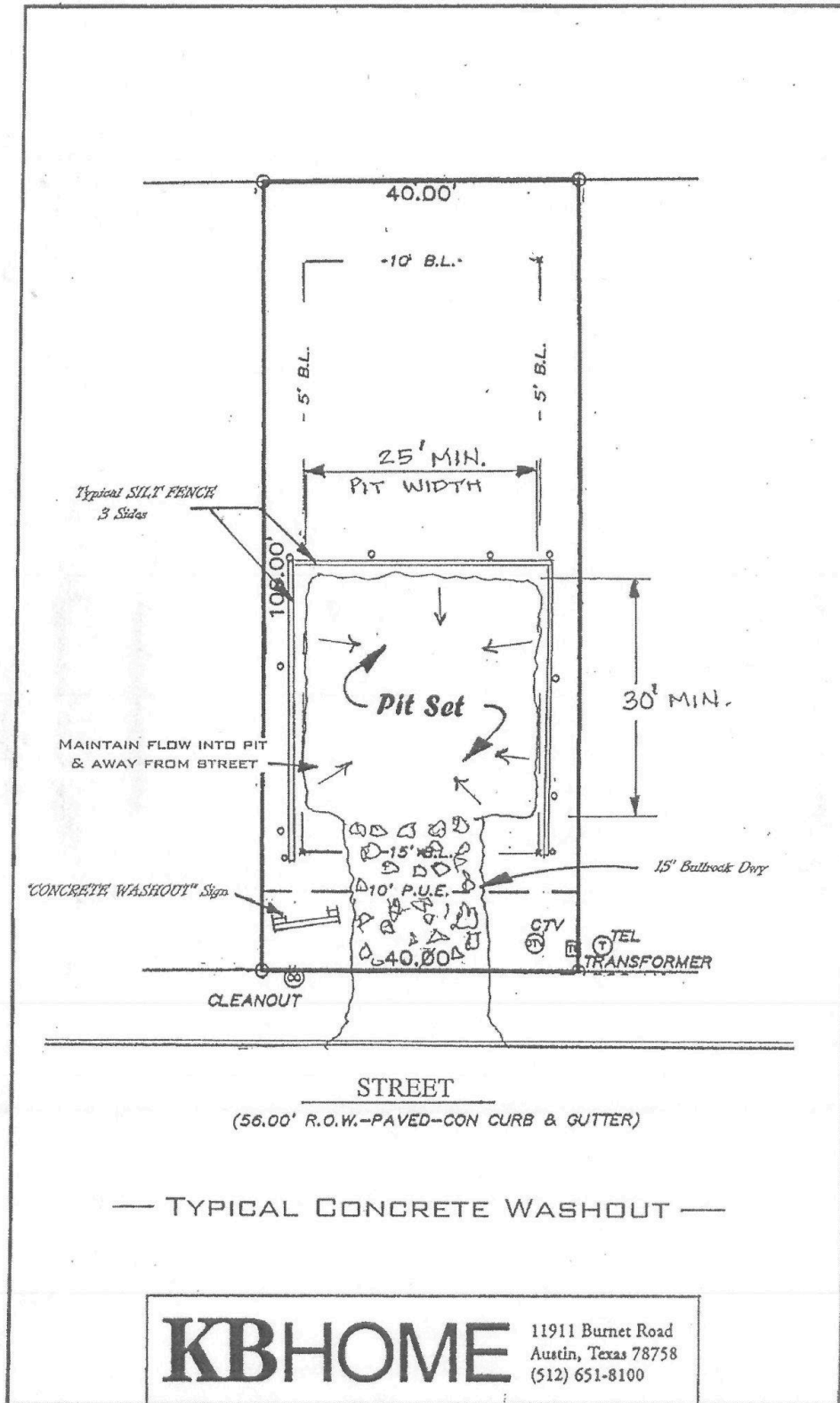

Figure 1-43 Schematics of Concrete Washout Areas

Storm Water Pollution Prevention Plan
 For Espino Tract, 16-inch Offsite Water Line (Oversized)



Storm Water Pollution Prevention Plan
For Espino Tract, 16-inch Offsite Water Line (Oversized)

PORTABLE CONCRETE WASHOUT CONTAINER

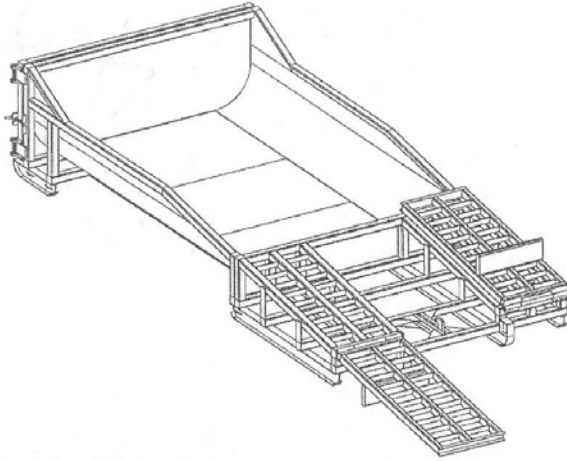

**CONCRETE
WASHOUT SYSTEMS**

PO Box 2604
Carmichael, CA. 95609
Phone: 1.877.292.7468
Fax: 1.916.244.0403
info@concretewashout.com
www.concretewashout.com
Patent Pending

DESCRIPTION

A portable, self-contained and watertight container affixed with ramps that controls, captures and contains caustic concrete wastewater and washout material.

PURPOSE & OBJECTIVE

Allows trade personnel to easily washout concrete trucks, pumps and other equipment associated with cement on site and allows easy off site recycling of the same concrete materials and wastewater.

APPLICATION

Construction projects where concrete, stucco, mortar, grout and cement are used as a construction material or where cementitious wastewater is created.

MAINTENANCE

Inspect and clean out when $\frac{3}{4}$ full, not allowing the container to overflow.

Inspect wastewater level and request a vacuum if needed.

Inspect subcontractors to ensure that proper housekeeping measures are employed when washing out equipment.

SPECIFICATIONS

The container must be portable and temporary, watertight, equipped with ramps and have a holding capacity to accept washout from approximately 350 yards of poured concrete. A vacuum service must accompany washout container and be used by site superintendent as needed. A rampless container may be used in conjunction with a ramped container or by itself if a concrete pump is not needed. The washwater must be disposed of or treated and recycled in an environmentally safe manner and in accordance with federal, state or local regulatory guidelines.

TARGETED POLLUTANTS

Caustic wastewater (high pH level near 12 units)

Suspended solids

Assorted Metals; Chromium VI, Nickel, Sulfate, Potassium, Magnesium and Calcium Compounds

Storm Water Pollution Prevention Plan
For Espino Tract, 16-inch Offsite Water Line (Oversized)

6. Dewatering

Dewatering Details

Discharges from dewatering activities, including discharges from dewatering of trenches and excavations, are prohibited, unless managed by appropriate controls to address sediment and prevent erosion. Operators must perform an inspection of the dewatering controls once per day while the dewatering discharge occurs as described in Part III.F.7. of this general permit.

Inspection of Dewatering Controls Pursuant to Part IV.C. of this General Permit

(a) personnel provided by the permittee must inspect dewatering controls at a minimum of once per day on the days where dewatering discharges occur. Personnel conducting these inspections must be knowledgeable of this general permit, the construction activities at the site, and the SWP3 for the site. Personnel conducting these inspections are not required to have signatory authority for inspection reports under 30 TAC § 305.128 (relating to Signatories to Reports).

(b) Requirements for Inspections

i. a report summarizing the scope of any inspection must be completed within 24-hours following the inspection. The report must also include, at a minimum, the following:

(A) date of the inspection;

(B) name(s) and title(s) of personnel making the inspection;

(C) approximate times that the dewatering discharge began and ended on the day of inspection;

(D) estimates of the rate (in gallons per day) of discharge on the day of inspection;

(E) whether or not any indications of pollutant discharge were observed at the point of discharge (e.g., foam, oil sheen, noticeable odor, floating solids, suspended sediments, or other obvious indicators of stormwater pollution);

(F) major observations, including: the locations of where erosion and discharges of sediment or other pollutants from the site have occurred; locations of BMPs that need to be maintained; locations of BMPs that failed to operate as designed or proved inadequate for a particular location; and locations where additional BMPs are needed.

ii. actions taken as a result of inspections, including the date(s) of actions taken, must be described within, and retained as a part of, the SWP3. Reports must identify any incidents of non-compliance. Where a report does not identify any incidents of non-compliance, the report must contain a certification that the facility or site is in compliance with the SWP3 and this permit. The report must be retained as part of the SWP3 and signed by the person and in the manner required by 30 TAC § 305.128 (relating to Signatories to Reports).

iii. the names and qualifications of personnel making the inspections for the permittee may be documented once in the SWP3 rather than being included in each report.

Storm Water Pollution Prevention Plan
For Espino Tract, 16-inch Offsite Water Line (Oversized)

DEWATERING EVALUATION FORM

Dewatering Evaluation			
<i>This form is Pursuant to Part IV.C. of the Texas Construction General Permit TXR150000 2023.</i>			
Site Name:	Date of Evaluation:		
Approximate Start & End Time of Dewatering on the Day of Evaluation Start Time _____ End Time _____	Continuous? <input type="checkbox"/>		
Estimated Rate of Discharge (gallons / day):			
Location of Dewatering Operations:			
Personnel Name and Position Title	Contact Information		
Qualifications of Personnel I am knowledgeable of the Texas Construction General Permit TXR150000, the construction activities at the site, and the SWP3 for this site. <input type="checkbox"/>			
Evaluation Results			
Are there any indications of pollutant discharge observed at the point of discharge (e.g., foam, oil sheen, noticeable odor, floating solids, suspended sediments, or other obvious indicators of stormwater pollution)?	Yes / No / N/A		
Has a visible amount of sediment been discharged beyond the permitted limits of disturbance due to dewatering activity?	Yes / No / N/A		
Has a visible amount of sediment been discharged into receiving waters, including wetlands due to dewatering activity?	Yes / No / N/A		
Are any BMPs used in the dewatering activity not in effective operating condition?	Yes / No / N/A		
Are any additional BMPs necessary for the dewatering activity?	Yes / No / N/A		
Are any BMPs inadequate and alternative BMPs necessary for the dewatering activities?	Yes / No / N/A		
Compliance Statement			
There were no incidents of noncompliance noted during this dewatering evaluation. The dewatering activity is in compliance with the SWPPP and the Texas Construction General Permit. <input type="checkbox"/>			
Corrective Action Log			
Deficiency	Action Taken	Date of Observation	Date Action Taken
PERSONNEL CERTIFICATION			
I certify under the penalty of law that this document and all attachments were prepared under my direction or supervision in accordance with a system designed to assure that qualified personnel properly gather and evaluate the information submitted. Based on my inquiry of the person or persons who manage the system, or those persons directly responsible for gathering the information, the information submitted is, to the best of my knowledge and belief, true, accurate, and complete. I am aware that there are significant penalties for submitting false information, including the possibility of fine and imprisonment for knowing violations.			
Personnel Name & Title		Signature of Personnel	
SIGNATORY CERTIFICATION in accordance with required by 30 TAC § 305.128 (relating to Signatories to Reports)			
I certify under the penalty of law that this document and all attachments were prepared under my direction or supervision in accordance with a system designed to assure that qualified personnel properly gather and evaluate the information submitted. Based on my inquiry of the person or persons who manage the system, or those persons directly responsible for gathering the information, the information submitted is, to the best of my knowledge and belief, true, accurate, and complete. I am aware that there are significant penalties for submitting false information, including the possibility of fine and imprisonment for knowing violations.			
Signatory Name & Title		Signature of Signatory	

Storm Water Pollution Prevention Plan
For Espino Tract, 16-inch Offsite Water Line (Oversized)

7. Spill Prevention and Response

Spill Response Protocol

Spills will be prevented utilizing Best Management Practices previously described beginning in Section IV such as proper material storage, handling, and disposal practices. However, despite such efforts, a spill may occur on site. If a spill occurs, the following procedures will be utilized.

- ***Stop the spill, if possible.*** This can include shutting off power to a pump, righting an overturned container, or plugging a hole in a damaged container.
- ***Contain the spill, safely.*** Spill containment can be accomplished using a variety of materials and methods such as the use of absorbents (i.e. sawdust, Oil Dri, rags, soil, polypropylene pads or booms, etc.) to dike the area around the spill, or placing a leaking container inside one which is not leaking. Spill containment should only be attempted if it is safe to do so. Proper safety equipment such as gloves and eye protection should be used as directed on the Material Safety Data Sheet for the spilled material.
- ***Report the spill, if necessary.*** Certain quantities of hazardous or toxic materials such as pesticides, paint thinners, gasoline, etc. are required by Federal Law to be reported to the National Response Center (NRC) at 1-800-424-8802 as soon as you have knowledge of the spill. Since most of the quantities which require reporting to the NRC are larger than that found on a typical construction site, spill reporting to the State or Local authorities is more likely. When in doubt, report the spill.

Texas Commission on Environmental Quality (TCEQ) **1-800-832-8224**

- ***Clean the spill up, properly.*** Spill clean up should be performed in accordance with applicable regulations or according to the manufacturer's recommendations on the Material Safety Data Sheet. In most cases, proper spill clean up is to use a dry method such as absorbing the spill and containerize for disposal via a licensed disposal company. For non-hazardous and non-toxic materials this may be through your solid waste disposal service with prior approval.
- ***Fill in table on next page.***

The SWPPP must be modified within 14 days of a release to provide a description of the spill, the circumstances leading to the spill, and the date of the spill. Spill clean-up materials, methods, and additional Best Management Practices addressing spill prevention should also be included.

Storm Water Pollution Prevention Plan
 For Espino Tract, 16-inch Offsite Water Line (Oversized)

Spill Date	Material Spilled	~ amount of spill (in gallons)	Circumstance of Spill (what caused the spill)	Corrective Action	Correction Date & sign-off

Storm Water Pollution Prevention Plan
For Espino Tract, 16-inch Offsite Water Line (Oversized)

8. Inspection Requirements

Inspection Frequency

At least once **every seven (7) days** the SWPPP provides for a thorough inspection of disturbed areas of the construction site that have not been finally stabilized.

If the inspection frequency changes, the reason for the change and the dates that the change is effective will be listed below.

Alternate Inspection Schedule:			Date range of alternate inspection schedule.	Reason for changing inspection schedule:
Every 7 days (weekly)	Every 7 days (weekly) and after rainfall events in excess of 0.5"	Monthly	Beginning Date-Ending Date	
			--	
			--	
			--	

Inspection Report Requirements

Inspection Reports will contain:

- A report summarizing the scope of any inspection must be completed within 24-hours following the inspection. The report must also include the date(s) of the inspection and major observations relating to the implementation of the SWP3. Major observations in the report must include: the locations of where erosion and discharges of sediment or other pollutants from the site have occurred; locations of BMPs that need to be maintained; locations of BMPs that failed to operate as designed or proved inadequate for a particular location; and locations where additional BMPs are needed.
- Actions taken as a result of inspections, including the date(s) of actions taken, must be described within, and retained as a part of, the SWP3. Reports must identify any incidents of non-compliance. Where a report does not identify any incidents of non-compliance, the report must contain a certification that the facility or site is in compliance with the

Storm Water Pollution Prevention Plan
For Espino Tract, 16-inch Offsite Water Line (Oversized)

SWP3 and this permit. The report must be retained as part of the SWP3 and signed by the person and in the manner required by 30 TAC § 305.128 (relating to Signatories to Reports).

- The names and qualifications of personnel making the inspections for the permittee may be documented once in the SWP3 rather than being included in each report.

The SWP3 must be modified based on the results of inspections, as necessary, to better control pollutants in runoff. Revisions to the SWP3 must be completed within seven (7) calendar days following the inspection. If existing BMPs are modified or if additional BMPs are necessary, an implementation schedule must be described in the SWP3 and wherever possible those changes implemented before the next storm event. If implementation before the next anticipated storm event is impracticable, these changes must be implemented as soon as practicable. If necessary, modify your site map to reflect changes to your stormwater controls that are no longer accurately reflected on the current site map.

Inspection and Entry

The permittee shall allow the Director or authorized representative of EPA, the State/Tribal, or municipal separate storm sewer authorized representative, upon the presentation of credentials and other documents as may be required by law to enter upon the permittee's premises where a regulated facility is located or conducted, have access to and copy any records that must be kept, and inspect any facility or equipment.

Qualified Personnel

Disturbed areas and areas used for storage of materials that are exposed to precipitation shall be inspected for evidence of, or the potential for, pollutants entering the drainage system. This site inspection will be performed by qualified personnel familiar with the site and with the authority to ensure necessary maintenance of controls **(in the Travis County and SAWS jurisdictions, these inspections are required to be performed by a Professional Engineer (P.E.) or a certified person with a CPESC, CESSWI, and/or CISEC certifications)**. Documentation of the inspection and actions taken is provided on forms shown in Appendix B.

Qualified personnel performing inspections are familiar with the BMPs, have knowledge to determine when a failed control is inadequate and needs to be replaced, have access to the construction schedule, have knowledge of stabilization, and have authority to make changes to the SWPPP.

KB Home Lone Star, Inc. has elected to have Compliance Resources, Inc. staff perform the required inspections.

Storm Water Pollution Prevention Plan For Espino Tract, 16-inch Offsite Water Line (Oversized)

Storm Water Pollution Prevention Plan Writer Qualifications for Compliance Resources, Inc.

Kassie Gnospelius, CESSWI (with CRI since September 2006)

- Bachelor of Science (BS) in Bioenvironmental Science from Texas A&M University, College Station, Texas
- Coursework in soil and crop science, bioremediation, and bioenvironmental science
- Internship with Texas A&M University Geochemical and Environmental Research Group, working as a lab technician testing various tissue and water samples for hazardous contaminants
- Successfully completed an internal training course on Best Management Practices and Texas Pollutant Discharge Elimination System (TPDES) requirements for construction activities
- Qualified Inspector
- Field Supervisor / Team Leader (May 2013 – April 2017)
- Houston Area Manager (May 2017 – current)
- Qualified Construction Storm Water Pollution Prevention Plan Writer (since March 2025)
- CESSWI #0774 – Certified Erosion, Sediment and Storm Water Inspector (March 2010)

Kassie Ledum, CPESC - IT, CESSWI (with CRI since July 2019)

- Bachelor of Science (BS) in Environmental Science with a minor in Biology from Texas A&M University at Corpus Christi, Corpus Christi, Texas
- Coursework in environmental regulations and policy, ecology, field biology, waste management, issues in environmental science, marine ecology, environmental geology, and Geographic Information Systems (GIS)
- HAZWOPER and Oil Spill Management Certified
- Experience in conducting field work and analyzing data
- Water Quality experience in collecting/ testing samples and reporting/analyzing data
- Experience in environmental education including the promotion of environmental conservation and implementation of program initiatives SEEDS (Strategies for Ecology, Education, Diversity, and Sustainability)
- Successfully completed an internal training course on Best Management Practices and Texas Pollutant Discharge Elimination System (TPDES) requirements for construction activities
- Qualified Inspector
- Qualified Construction Storm Water Pollution Prevention Plan Writer (since July 2021)
- Senior Construction Storm Water Pollution Prevention Plan Writer (October 2022 – current)
- CESSWI – IT #5702 – Certified Erosion, Sediment and Storm Water Inspector - In Training (January 2020)
- CESSWI #5702 – Certified Erosion, Sediment and Storm Water Inspector (November 2020)
- CPESC – IT #12181 – Certified Professional in Erosion and Sediment Control – In Training (October 2022)

Amber Scheler, CPESC (with CRI since January 2005)

- Coursework in Computer-Aided Design at Temple College, Temple, Texas
- Applicable coursework in computer-aided design, AutoCAD, drafting, and environmental science
- Experience as an Administrative/Research Assistant for surveying company (2 years) and an SWP3 Writer since January 2005
- Sediment & Erosion Control Master Class: Evaluating Erosion, Sediment, & Sedimentation (six week course; April – May 2012)
- Attended a CESSWI review course (part 1) in October 2013
- Successfully completed an internal training course on Best Management Practices and Texas Pollutant Discharge Elimination System (TPDES) requirements for construction activities
- Qualified Construction Storm Water Pollution Prevention Plan Writer (since June 2005)
- Storm Water Pollution Prevention Plan Supervisor / Team Leader (January 2007 – December 2017)
- Storm Water Pollution Prevention Plan Assistant Manager (January 2018 – November 2018)
- Storm Water Pollution Prevention Plan Manager (December 2018 – current)
- StormwaterONE Certification - Qualified Preparer of Storm Water Pollution Prevention Plans #4475000 – Texas (October 2017 - October 2019)
- StormwaterONE Certification - Qualified Compliance Inspector of Storm Water #4475000 – Texas (October 2017 - October 2019)
- CPESC – IT #9219 – Certified Professional in Erosion and Sediment Control – In Training (October 2018)
- CPESC #9219 – Certified Professional in Erosion and Sediment Control (December 2018)

Misti Shafer-Webb, CPESC, CESSWI (with CRI since September 2002)

- Bachelor of Science (BS) in Environmental Design from Texas A&M University, College Station, Texas
- Bachelor of Science (BS) in Construction Science from Texas A&M University, College Station, Texas
- Coursework in project management, soil science, environmental science, construction materials and methods, AutoCAD, drafting, surveying, concrete and steel structural engineering, and environmental design
- Internship with DPR Construction in their OSHA/Safety department
- Two years of experience in the homebuilding construction industry including permitting and project coordinating for David Weekley Homes in Austin, Texas and Houston, Texas
- Attended various trainings / conferences through Environmental Protection Agency (EPA), Texas Commission on Environmental Quality (TCEQ), Edwards Aquifer Protection Program (EAPP), International Erosion Control Association (IECA), South Central International Erosion Control Association (SCIECA), StormCon, Capital Area Erosion Control Network (CAECN), Home Builders Association (HBA), and the Austin Contractors and Engineers Association (ACEA)

Storm Water Pollution Prevention Plan For Espino Tract, 16-inch Offsite Water Line (Oversized)

- National Association of Women in Construction (Austin Chapter #7) Parliamentarian 2024-2025, Immediate Past-President 2022-2023, President 2021-2022, President-Elect 2020-2021, Director 2019-2020, Director 2018-2019, Vice President 2017-2018, and Director 2016-2017
- Successfully completed an internal training course on Best Management Practices and Texas Pollutant Discharge Elimination System (TPDES) requirements for construction activities
- Qualified Inspector
- Office Manager (December 2002 – August 2003)
- Qualified Construction Storm Water Pollution Prevention Plan Writer (since July 2003)
- Storm Water Pollution Prevention Plan Manager (September 2003 – November 2018)
- Austin Area Manager (June 2004 – May 2006; March 2009 – December 2011)
- President and Owner (July 2018 – current)
- CPESC #5381 – Certified Professional in Erosion and Sediment Control (August 2009)
- CESSWI #0698 – Certified Erosion, Sediment and Storm Water Inspector (August 2009)

Inspector Qualifications for Compliance Resources, Inc.

Juleitzy Amador Aviles, CESSWI - IT (with CRI since August 2022)

- Bachelor of Science (BS) in Multidisciplinary Studies in Environmental Science with smaller focuses of Anthropology and Women's Studies from The University of Texas at San Antonio, San Antonio, Texas
- Coursework in zoology, botany, geology, ecology, Environmental law, ecology, and conservation biology
- Experience with customer service, quality assurance and control, Microsoft and Google applications
- Successfully completed an internal training course on Best Management Practices and Texas Pollutant Discharge Elimination System (TPDES) requirements for construction activities
- Qualified Inspector
- CESSWI – IT #9611 – Certified Erosion, Sediment and Storm Water Inspector - In Training (April 2023)

Bryton Calder, CESSWI - IT (with CRI since August 2024)

- Bachelor of Arts (BS) in Environmental Studies with a concentration in Urban Sustainability from New College of Florida, Sarasota, Florida
- Coursework in biology, ecology, environmental governance, sustainability, sociology, urbanism, food systems and distribution, and sustainable agriculture
- Experience conducting fieldwork with emphasis on sample collection, site monitoring, and biological and ecological systems
- Experience with Geographic Information Systems (GIS) and data collection and management
- Published scientific work within the field of herpetology, conducted through research involving biological and ecological sample collection
- Successfully completed an internal training course on Best Management Practices and Texas Pollutant Discharge Elimination System (TPDES) requirements for construction activities
- Qualified Inspector
- CESSWI – IT #12904 – Certified Erosion, Sediment and Storm Water Inspector - In Training (October 2024)

Christopher Calvillo, CESSWI (with CRI since July 2021)

- Bachelor of Science (BS) in Environmental Science from The University of the Incarnate Word, San Antonio, Texas
- Coursework in soil conservation, biology, ecology, environmental geology, and water quality
- Experience in customer service as a Park Ranger, assisting with education of the public as well as enforcement of city ordinances
- Successfully completed an internal training course on Best Management Practices and Texas Pollutant Discharge Elimination System (TPDES) requirements for construction activities
- Qualified Inspector
- CESSWI – IT #6033 – Certified Erosion, Sediment and Storm Water Inspector - In Training (November 2021)
- CESSWI #6033 – Certified Erosion, Sediment and Storm Water Inspector (August 2022)

Justin Croon, CESSWI (with CRI since September 2006)

- Bachelor of Science (BS) in Political Science from Texas A&M University, College Station, Texas
- Coursework in geography and geology
- Experienced in customer service and office administration
- Successfully completed an internal training course on Best Management Practices and Texas Pollutant Discharge Elimination System (TPDES) requirements for construction activities
- Qualified Inspector
- CESSWI #1903 – Certified Erosion, Sediment and Storm Water Inspector (August 2011)

Sierra Elizondo, CESSWI - IT (with CRI since July 2024)

- Bachelor of Science (BS) in Biology with a minor in Chemistry from Texas Tech University at Waco, Waco, Texas
- Bachelor of Science (BS) in Wildlife Biology with a minor in Geology from Texas State University, San Marcos, Texas

Storm Water Pollution Prevention Plan For Espino Tract, 16-inch Offsite Water Line (Oversized)

- Coursework in field ecology, parasitology, technical writing, invertebrate zoology, chemistry, mammalogy, tropical marine biology, structural geology, geomorphology, earth materials, sedimentation and stratigraphy, ecology, raptor ecology, wetland plant ecology management, wildlife management and techniques wildlife management, ecology of rarity, and statistic behavioral science
- Work alongside the Mammal Department at the Cameron Park Zoo as a Summer Intern helping keepers in animal husbandry and enrichment planning in the hoofstock, primates, elephant, rhinos, bears, and large cat areas
- Volunteer alongside Friends of McKinney Falls State Park once a month to clean trash
- Experience in research, conservation, field work, hand tools, and data collection and analysis
- Successfully completed an internal training course on Best Management Practices and Texas Pollutant Discharge Elimination System (TPDES) requirements for construction activities
- Qualified Inspector
- CESSWI – IT #12882 – Certified Erosion, Sediment and Storm Water Inspector - In Training (September 2024)

Joshua Garcia, CESSWI - IT (with CRI since August 2024)

- Bachelor of Arts (BA) in Environmental Studies from Brown University, Providence, Rhode Island
- Coursework in environmental policy, environmental remediation, environmental management, environmental economics, waste management, ecology, urban studies, conservation, climate science, microbiology, sustainability, and chemistry
- Conducted an independent ethnographic research study on the sources of water-related public health risk in Morocco, Nepal, and Ecuador that included interviews with environmental experts and visits to wastewater treatment facilities and contaminated sites
- Experience in water quality testing and sample collection through an environmental laboratory working on environmental remediation at the University of Barcelona as a laboratory assistant
- Experience in soil testing and land use planning as a logistics coordinator at the Brown Student Garden
- Successfully completed an internal training course on Best Management Practices and Texas Pollutant Discharge Elimination System (TPDES) requirements for construction activities
- Qualified Inspector
- CESSWI – IT #12937 – Certified Erosion, Sediment and Storm Water Inspector - In Training (December 2024)

Jackson Giminiani, CESSWI (with CRI since September 2021)

- Bachelors of Science (BS) in Wildlife and Fisheries Science from Texas A&M University, College Station, Texas
- Coursework in ecology, environmental monitoring, techniques of wildlife management, principles of fisheries management, and fish and wildlife laws and administration
- Experience in educating the public about water conservation and habitat restoration for endangered species specifically at the headwaters of the San Marcos River
- Successfully completed an internal training course on Best Management Practices and Texas Pollutant Discharge Elimination System (TPDES) requirements for construction activities
- Qualified Inspector
- Field Supervisor / Team Leader (January 2023 – current)
- CESSWI – IT #6058 – Certified Erosion, Sediment and Storm Water Inspector - In Training (December 2021)
- CESSWI #6058 – Certified Erosion, Sediment and Storm Water Inspector (October 2022)

Kassie Gnospelius, CESSWI (with CRI since September 2006)

- Bachelor of Science (BS) in Bioenvironmental Science from Texas A&M University, College Station, Texas
- Coursework in soil and crop science, bioremediation, and bioenvironmental science
- Internship with Texas A&M University Geochemical and Environmental Research Group, working as a lab technician testing various tissue and water samples for hazardous contaminants
- Successfully completed an internal training course on Best Management Practices and Texas Pollutant Discharge Elimination System (TPDES) requirements for construction activities
- Qualified Inspector
- Field Supervisor / Team Leader (May 2013 – April 2017)
- Houston Area Manager (May 2017 – current)
- Qualified Construction Storm Water Pollution Prevention Plan Writer (since March 2025)
- CESSWI #0774 – Certified Erosion, Sediment and Storm Water Inspector (March 2010)

Patrick Hodgkiss, CESSWI (with CRI since August 2017)

- Coursework towards a Bachelor of Science (BS) in Environmental Management from Columbia Southern University, Orange Beach, Alabama
- Coursework in environmental law, environmental assessment, air quality, hazardous, waste management, technical writing, pollution prevention, toxicology, waste management, and environmental issues
- Proficient in the application, execution, supervision, and management of all aspects of Military Munitions Response Actions including Site Visits, Remediation Investigations and Removal Actions
- Over 12,681 hours of environmental remediation experience at 22 project locations throughout the United States to include experience in implementing Storm Water Pollution Prevention Plans, Soil Sampling Plans, and Water Monitoring Activities
- Three years of experience as a quality control specialist in the Unexploded Ordinance industry requiring collaboration with clients and regulatory specialists to develop practical compliance requirements
- ACEA Regulatory Committee member since Spring 2019
- Successfully completed an internal training course on Best Management Practices and Texas Pollutant Discharge Elimination System (TPDES) requirements for construction activities

Storm Water Pollution Prevention Plan For Espino Tract, 16-inch Offsite Water Line (Oversized)

- Qualified Inspector
- Austin Area Manager (August 2017 – June 2019)
- Corporate Trainer (December 2018 – current)
- Director of Business Development (July 2019 – June 2021)
- Chief Operations Officer (July 2021 – current)
- CESSWI #5228 – Certified Erosion, Sediment and Storm Water Inspector (April 2018)

Hayle Johnson, CESSWI - IT (with CRI since July 2024)

- Bachelor of Science (BS) in Geography with a minor in Environmental Science from Sam Houston State University, Huntsville, Texas
- Coursework in environmental science, sustainability and environment, conservation of natural resources, environmental and cultural geography, weather and climate, computer cartography, general botany, physical and environmental geology, soil science, general ecology, hydrology and water resources, field studies, and Geographic Information Systems (GIS)
- Worked under the National Parks Service at the San Antonio Missions State Park with Texas Conservation Corps conserving and preserving the historical acequia
- Worked at Bastrop State Park with Texas Conservation Corps on a trail construction project and an amphibian reptile exclusionary fence to preserve the Houston toad
- Volunteered at Head Waters Sanctuary to remove invasive grasses and plants
- Volunteered with Bexar Branches Project Canopy to plant 500 trees with children across five elementary schools in Bexar County
- First Aid and CPR training certified
- Experience in conservation, field work, hand tools, research, education, GIS, data collection and analysis
- Successfully completed an internal training course on Best Management Practices and Texas Pollutant Discharge Elimination System (TPDES) requirements for construction activities
- Qualified Inspector
- CESSWI – IT #12876 – Certified Erosion, Sediment and Storm Water Inspector - In Training (September 2024)

Ashleigh Kirby, CESSWI (with CRI since June 2023)

- Bachelor of Science (BS) in Environmental Science from The University of Texas at San Antonio, San Antonio, Texas
- Coursework in ecology, watershed processes, natural resources and policy administration, environmental law, botany, geology, plant identification, global changes, soils, environmental statistics, and Geographic Information Systems (GIS)
- Fieldwork experience in performing ecological surveys, vegetation identification and sampling
- Experience in environmental education, customer service and quality assurance
- Knowledge of Microsoft office applications, Google applications, JMP, Java, and Geographic Information Systems (GIS)
- Successfully completed an internal training course on Best Management Practices and Texas Pollutant Discharge Elimination System (TPDES) requirements for construction activities
- Qualified Inspector
- CESSWI – IT #12053 – Certified Erosion, Sediment and Storm Water Inspector - In Training (December 2023)
- CESSWI #12053 – Certified Erosion, Sediment and Storm Water Inspector (July 2024)

Elijah LaChapelle, CESSWI - IT (with CRI since October 2024)

- Bachelor of Science in Wildlife Biology from Texas State University, San Marcos, Texas
- Coursework in biology, wildlife management, food and society, conservation of biological resources, techniques in wildlife management, and plant ecology
- Experience conducting fieldwork to create a management plan
- Successfully completed an internal training course on Best Management Practices and Texas Pollutant Discharge Elimination System (TPDES) requirements for construction activities
- Qualified Inspector
- CESSWI – IT #12923 – Certified Erosion, Sediment and Storm Water Inspector - In Training (November 2024)

Kassie Ledum, CPESC - IT, CESSWI (with CRI since July 2019)

- Bachelor of Science (BS) in Environmental Science with a minor in Biology from Texas A&M University at Corpus Christi, Corpus Christi, Texas
- Coursework in environmental regulations and policy, ecology, field biology, waste management, issues in environmental science, marine ecology, environmental geology, and Geographic Information Systems (GIS)
- HAZWOPER and Oil Spill Management Certified
- Experience in conducting field work and analyzing data
- Water Quality experience in collecting/ testing samples and reporting/analyzing data
- Experience in environmental education including the promotion of environmental conservation and implementation of program initiatives SEEDS (Strategies for Ecology, Education, Diversity, and Sustainability)
- Successfully completed an internal training course on Best Management Practices and Texas Pollutant Discharge Elimination System (TPDES) requirements for construction activities
- Qualified Inspector
- Qualified Construction Storm Water Pollution Prevention Plan Writer (since July 2021)
- Senior Construction Storm Water Pollution Prevention Plan Writer (October 2022 – current)
- CESSWI – IT #5702 – Certified Erosion, Sediment and Storm Water Inspector - In Training (January 2020)
- CESSWI #5702 – Certified Erosion, Sediment and Storm Water Inspector (November 2020)
- CPESC – IT #12181 – Certified Professional in Erosion and Sediment Control – In Training (October 2022)

Storm Water Pollution Prevention Plan For Espino Tract, 16-inch Offsite Water Line (Oversized)

Christopher Lord, CESSWI (with CRI since March 2014)

- Bachelor of Science (BS) in Geology from The University of Houston, Houston, Texas
- Associate of Arts (AA) in Geology from San Jacinto College, Houston, Texas
- Coursework in geography, petrology, stratigraphy, mineralogy, environmental geology, environmental biology, physical geology, meteorology, and Geographic Information Systems (GIS)
- Seven years of laboratory experience in geology and chemistry
- Experience in residential and industrial plumbing construction
- Successfully completed an internal training course on Best Management Practices and Texas Pollutant Discharge Elimination System (TPDES) requirements for construction activities
- Qualified Inspector
- Field Supervisor / Team Leader (March 2019 – current)
- CESSWI – IT #4243 – Certified Erosion, Sediment and Storm Water Inspector - In Training (November 2014)
- CESSWI #4243 – Certified Erosion, Sediment and Storm Water Inspector (August 2016)

Luke Nelson (with CRI since July 2024)

- Bachelor of Science (BS) in Geography with a minor in Geospatial Science from Sam Houston State University, Huntsville, Texas
- Coursework in computer cartography, remote sensing, hydrology and water resources, field studies, environmental and cultural geography, weather and climate, economic geography, conservation of natural resources, tourism geography, plant science, cultural geography field studies, and Geographic Information Systems (GIS)
- Completed a field project that included gathering data points, lines and polygons on handheld GPS devices and analyzing that data in ArcGIS Pro illustrating potential erosion hazard zones and potential mitigation strategies along the cart path at the Panorama Village Golf Course in Panorama Village, Texas
- Created a health outcome map in ArcGIS Pro showing the link between low income and poor health outcomes such as mental health and cancer rates using U.S. Census Data
- Created a prospective Market Analysis for a new Rural King feed store location in Boonville, Missouri based on income and farm production data gathered from the USDA database
- Volunteered at the Sustain Huntsville Garden
- Engaged in habitat restoration projects in Punta Islita, Costa Rica at the Macaw Recovery Network's wild macaw reserve building nesting boxes and enrichment devices as well as engaged in habitat cleanup that had become polluted with debris and trash
- Successfully completed an internal training course on Best Management Practices and Texas Pollutant Discharge Elimination System (TPDES) requirements for construction activities
- Qualified Inspector

Gretchen Reutzel, CPESC, CESSWI (with CRI since November 2005)

- Bachelor of Science (BS) in Environmental Science and Resource Management from Texas State University, San Marcos, Texas
- Coursework in environmental science, natural resource protection, aquatic biology, land planning, and watershed management
- Environmental Education Coordinator at Texas State University (8 years)
- Watershed Manager at the Upper Guadalupe River Authority (2 years)
- San Antonio Area Informal Education Association (SAIEA) Board Member
- Developed and published environmental curriculum distributed to local museums, river authorities, and universities
- Worked with federal, state and local regulations agencies to develop watershed and water quality programs to manage Central Texas rivers and the Edwards Aquifer
- Successfully completed the San Antonio Water System (SAWS) Texas Pollutant Discharge Elimination Systems (TPDES) Inspector Workshop
- Successfully completed an internal training course on Best Management Practices and Texas Pollutant Discharge Elimination System (TPDES) requirements for construction activities
- Qualified Inspector
- Field Supervisor / Team Leader (November 2006 – September 2013)
- San Antonio Field Assistant Manager (October 2013 – May 2014)
- San Antonio Area Manager (June 2014 – March 2024)
- Director of Business Development (April 2024 – current)
- CESSWI #0689 – Certified Erosion, Sediment and Storm Water Inspector (August 2009)
- CPESC #6480 – Certified Professional in Erosion and Sediment Control (July 2011)

Scott Rippeth, CESSWI (with CRI since June 2023)

- Bachelor of Science (BS) in Environmental Science from The University of Texas at San Antonio, San Antonio, Texas
- Coursework in watershed processes, restoration ecology, soil science, environmental remediation, natural resource policy, environmental law, and Geographic Information Systems (GIS)
- Conducted an undergraduate independent study of the management of water quality through storm water regulation and low impact development projects to address total daily maximum load (TMDL) on impaired sections of the San Antonio River
- Experience in sample collection and water quality testing through Texas Stream Team as a Standard Core Water Quality Citizen Scientist and a Riparian Evaluation Citizen Scientist

Storm Water Pollution Prevention Plan For Espino Tract, 16-inch Offsite Water Line (Oversized)

- Successfully completed an internal training course on Best Management Practices and Texas Pollutant Discharge Elimination System (TPDES) requirements for construction activities
- Qualified Inspector
- CESSWI – IT #11928 – Certified Erosion, Sediment and Storm Water Inspector - In Training (November 2023)
- CESSWI #11928 – Certified Erosion, Sediment and Storm Water Inspector (June 2024)

Misti Shafer-Webb, CPESC, CESSWI (with CRI since September 2002)

- Bachelor of Science (BS) in Environmental Design from Texas A&M University, College Station, Texas
- Bachelor of Science (BS) in Construction Science from Texas A&M University, College Station, Texas
- Coursework in project management, soil science, environmental science, construction materials and methods, AutoCAD, drafting, surveying, concrete and steel structural engineering, and environmental design
- Internship with DPR Construction in their OSHA/Safety department
- Two years of experience in the homebuilding construction industry including permitting and project coordinating for David Weekley Homes in Austin, Texas and Houston, Texas
- Attended various trainings / conferences through Environmental Protection Agency (EPA), Texas Commission on Environmental Quality (TCEQ), Edwards Aquifer Protection Program (EAPP), International Erosion Control Association (IECA), South Central International Erosion Control Association (SCIECA), StormCon, Capital Area Erosion Control Network (CAECN), Home Builders Association (HBA), and the Austin Contractors and Engineers Association (ACEA)
- National Association of Women in Construction (Austin Chapter #7) Parliamentarian 2024-2025, Immediate Past-President 2022-2023, President 2021-2022, President-Elect 2020-2021, Director 2019-2020, Director 2018-2019, Vice President 2017-2018, and Director 2016-2017
- Successfully completed an internal training course on Best Management Practices and Texas Pollutant Discharge Elimination System (TPDES) requirements for construction activities
- Qualified Inspector
- Office Manager (December 2002 – August 2003)
- Qualified Construction Storm Water Pollution Prevention Plan Writer (since July 2003)
- Storm Water Pollution Prevention Plan Manager (September 2003 – November 2018)
- Austin Area Manager (June 2004 – May 2006; March 2009 – December 2011)
- Owner and Chief Executive Officer (July 2018 – current)
- CPESC #5381 – Certified Professional in Erosion and Sediment Control (August 2009)
- CESSWI #0698 – Certified Erosion, Sediment and Storm Water Inspector (August 2009)

Eric Silva, CESSWI (with CRI since May 2022)

- Bachelors of Science (BS) in Biology from Texas A&M University at Kingsville/San Antonio, San Antonio, Texas
- Course work in ecology, invertebrate zoology, bacteriology, and biostatistics
- Experience in customer service
- Successfully completed an internal training course on Best Management Practices and Texas Pollutant Discharge Elimination System (TPDES) requirements for construction activities
- Qualified Inspector
- Field Supervisor / Team Leader (January 2025 - current)
- CESSWI – IT #7466 – Certified Erosion, Sediment and Storm Water Inspector - In Training (July 2022)
- CESSWI #7466 – Certified Erosion, Sediment and Storm Water Inspector (June 2023)

Hailey Thompson, CESSWI (with CRI since May 2018)

- Bachelor of Arts (BA) in Global Studies: Environments & Sustainability from The University of Virginia, Charlottesville, Virginia
- Coursework in ecology, biology, geography, water quality, sustainable communities, global sustainability, climate change science and policy, environmental economics, and oceanography
- Experience in economic analysis and evaluating cost-benefit scenarios to produce cost-effective solutions
- Successfully completed an internal training course on Best Management Practices and Texas Pollutant Discharge Elimination System (TPDES) requirements for construction activities
- Qualified Inspector
- Field Supervisor / Team Leader (October 2019 – June 2021)
- Quality Assurance Manager / Corporate Trainer (July 2021 – April 2024)
- Operations Manager (May 2024 – current)
- CESSWI – IT #5329 – Certified Erosion, Sediment and Storm Water Inspector - In Training (July 2018)
- CESSWI #5329 – Certified Erosion, Sediment and Storm Water Inspector (June 2019)

Megan Weiss, CESSWI - IT (with CRI since October 2023)

- Bachelor of Science (BS) in Environmental Science from The University of the Incarnate Word, San Antonio, Texas
- Coursework in hydrology, geology, meteorology, chemistry, microbiology, soil conservation, air pollution, and ecology
- Experience in customer service, volunteering, lab testing, water sampling, soil sampling, and air pollution monitoring
- Conducted GIS work & field work in internship at the City of San Marcos (Stormwater Division)
- Conducted lab technician work in microbiology as a lab teachers assistant
- Successfully completed an internal training course on Best Management Practices and Texas Pollutant Discharge Elimination System (TPDES) requirements for constructive activities
- Qualified Inspector
- CESSWI – IT #12232 – Certified Erosion, Sediment and Storm Water Inspector - In Training (February 2024)

**Storm Water Pollution Prevention Plan
For Espino Tract, 16-inch Offsite Water Line (Oversized)**

Hannah Welker, CESSWI (with CRI since March 2017)

- Associate of Art (AA) in Liberal Arts from Northwest Vista College, San Antonio, Texas
- Experience in customer service, auditing, and office administration
- 2.5 years of experience in SWPPP project management
- Working knowledge of applicable regulations (Federal, State, local), endangered species, and Edwards Aquifer issues
- Successfully completed an internal training course on Best Management Practices and Texas Pollutant Discharge Elimination System (TPDES) requirements for construction activities
- Qualified SWP3 Auditor
- Qualified Inspector
- Field Supervisor / Team Leader (March 2021 – current)
- CESSWI – IT #5729 – Certified Erosion, Sediment and Storm Water Inspector - In Training (April 2020)
- CESSWI #5729 – Certified Erosion, Sediment and Storm Water Inspector (August 2020)

Storm Water Pollution Prevention Plan
For Espino Tract, 16-inch Offsite Water Line (Oversized)

KB Sequence Inspection Form Sample:



Division _____
Site _____

Storm Water Site Inspection Report

Inspection Date: _____

Inspector: _____ Phone #: _____ Last Inspection Date: _____

Inspection Type: (circle one) Regular Rain Event Final
Weather: (circle one) Dry Rain Snow Icy

Note: Keep this completed Report and accompanying Responsive Action Log with the Storm Water Plan ("SWP") or be sure that access to the electronic versions of those documents on KB Sequence are easily accessible.

Outfalls, Entrances and Streets

A. <u>Outfalls:</u> Excess sediment or other pollutants controlled per SWP from leaving the Site?	Y	N	N/A
B. <u>Vehicle Tracking:</u> Installed and maintained per SWP?	Y	N	N/A
C. <u>Streets:</u> Excess soil kept off streets?	Y	N	N/A

Storm Water Controls

D. <u>Erosion and Sediment Controls:</u> Installed and maintained per SWP?	Y	N	N/A
E. <u>Soil Stabilization:</u> Implemented and maintained per SWP?	Y	N	N/A
F. <u>Stock Piles:</u> Properly located and stabilized per SWP?	Y	N	N/A

Non-Storm Water Controls

G. <u>Concrete, Stucco, Paint (etc.) Washouts:</u> Located, installed and maintained per SWP?	Y	N	N/A
H. <u>Waste Management & Material Storage:</u> Trash, debris, hazardous materials, and construction materials (including material storage areas) properly managed?	Y	N	N/A
I. <u>Sanitary Waste:</u> Portable toilets properly located and maintained?	Y	N	N/A

Storm Water Plan and Related Documents

J. Is the Site and Division Storm Water Compliance Representative ("SSWCR" and "DSWCR") contact information provided on Site; if so, is it current?	Y	N	N/A
K. If required, is the Applicable Permit and/or NOI on Site?	Y	N	N/A
L. Is the SWP available on Site or its location posted as required?	Y	N	N/A
M. Does the SWP match current Site conditions?	Y	N	N/A
N. Are BMPs required by the SWP appropriate for existing Site conditions?	Y	N	N/A
O. If there have been any government inspections evaluating compliance with the Applicable Permit (NPDES only) since the last Site Inspection, have all issues been addressed in response to that government inspection?	Y	N	N/A
P. Was the Site Inspection Report from the last Site Inspection (1) signed by the SSWCR and (2) certified if and as required by the Applicable Permit?	Y	N	N/A

Storm Water Pollution Prevention Plan
 For Espino Tract, 16-inch Offsite Water Line (Oversized)



Division
 Site

Storm Water Site Inspection Report

Inspection Date: _____

G. Have all Responsive Actions from prior Site Inspections been timely addressed? Y N N/A

If "N", list all actions that were not addressed or are not yet completed (explaining why, if known):
 (Note: For Responsive Actions identified during this inspection, use the Responsive Action Log on the following page.)

Uncompleted Reponsive Actions From Prior Inspections				
Responsive Action Number	Deficiency (Action Item)	Location	Date of Inspection	Explanation

 Name and Title of Inspector

 Signature of Inspector

 Date

Include a certification in this space when required by the Applicable Permit, using the certification language required by that Permit.

If anyone other than the Site Storm Water Compliance Representative for this Site performed the inspection, that Representative must review and sign the completed Site Inspection Report below:

 Name

 Signature

 Date

Storm Water Pollution Prevention Plan
For Espino Tract, 16-inch Offsite Water Line (Oversized)



Division _____
Site _____

Storm Water Site Inspection Report

Inspection Date: _____

Responsive Action Log

(for Action Items found during this inspection)

Ref #	Deficiency (Action Item)	Location	Addressed By	Date	Notes
Additional Comments:					

Storm Water Pollution Prevention Plan
For Espino Tract, 16-inch Offsite Water Line (Oversized)

10. Amendments

SWPPP AMENDMENT LOG	
Amendment Date:	Description of Changes

Storm Water Pollution Prevention Plan
For Espino Tract, 16-inch Offsite Water Line (Oversized)

Appendix A - SWPPP Signed Documents

CSN, Permit Certificate, NOI, NOC, NOT, Delegation Letter for Signatories to Reports, SWPPP Certification, Edwards Aquifer Regional Office notification (if applicable)



TCEQ Large Construction Site Notice

Primary Operator

Large construction sites disturb more than five acres or are part of a larger common plan of development that disturbs more than five acres. Primary operators of large construction sites will fill out this notice. Primary operators will then post this notice at the construction site in a location where it is safely and readily available for viewing by the general public and local, state, and federal authorities. Additional information about the TCEQ Construction Stormwater General Permit may be found on TCEQ's webpage on [Assistance Tools for Construction Stormwater General Permits](#).

Note: You must also develop a Stormwater Pollution Prevention Plan prior to the commencement of construction.

Site-Specific TPDES Authorization Number: TXR1503UU

Primary Operator Name: KB Home Lone Star, Inc.

Contact Name and Phone Number:
Ricardo Rodriguez 210-301-2899

Project Description:

Physical Location/Description: Espino Tract, 16-inch Offsite Water Line (KB) northeast of the intersection of Masterson Road and Hennersby Lane, San Antonio, TX 78252

Estimated Start Date: 12/15/2025

Projected End Date or Date Disturbed Soils Will Be Stabilized: 06/15/2026

Location of Stormwater Pollution Prevention Plan (SWP3):

Compliance Resources, Inc. 1103 Williams Drive, Bldg. 2 Georgetown, TX 78628 (Maintained Electronically)



TEXAS COMMISSION ON ENVIRONMENTAL QUALITY
Texas Pollutant Discharge Elimination System
Stormwater Construction General Permit

The Notice of Intent (NOI) for the facility listed below was received on June 2, 2025. The intent to discharge stormwater associated with construction activity under the terms and conditions imposed by the Texas Pollutant Discharge Elimination System (TPDES) stormwater Construction General Permit CGP TXR150000 is acknowledged. Your facility's unique TPDES CGP stormwater authorization is:

TXR1503UU

Coverage Effective: June 2, 2025

The TCEQ's stormwater CGP requires certain stormwater pollution prevention and control measures, possible monitoring and reporting, and periodic inspections. Among the conditions and requirements of this permit, you must have prepared and implemented a stormwater pollution prevention plan (SWP3) that is tailored to your construction site. As a facility authorized to discharge under the stormwater CGP, all terms and conditions must be complied with to maintain coverage and avoid possible penalties.

Project/Site Information:

RN112223730
ESPINO TRACT 16 INCH OFFSITE WATER LINE
NORTHEAST OF THE INTERSECTION OF MASTERSON ROAD AND
HENNERSBY LANE
SAN ANTONIO, TX 78252
BEXAR COUNTY

Operator:

CN603249053
KB HOME LONE STAR INC.
4800 FREDERICKSBURG RD
SAN ANTONIO, TX 78229-3628

This CGP and all authorizations expires on March 5, 2028, unless otherwise amended. If you have any questions related to processing of your application, you may contact the Stormwater Processing Center by **email at SWPERMIT@tceq.texas.gov** or by **telephone at (512) 239-3700**. For technical questions, you may contact the stormwater technical staff by email at SWG@tceq.texas.gov or by telephone at (512) 239-4671. Also, you may obtain information on the stormwater web site at <https://www.tceq.texas.gov/goto/wq-dpa>. A copy of this document should

Issued Date: June 03, 2025

A handwritten signature in cursive script that reads "K. Keel".

FOR THE COMMISSION



Texas Commission on Environmental Quality

Protecting Texas by Reducing and Preventing Pollution

June 3, 2025

Dear Applicant:

Re: TPDES General Permit for Construction Stormwater Runoff (TXR150000)
Notice of Intent Authorization

Your Notice of Intent (NOI) application for authorization under the general permit for discharge of stormwater associated with construction activities has been received. Pursuant to authorization from the Executive Director of the Texas Commission on Environmental Quality, the Division Deputy Director of the Water Quality Division has issued the enclosed Certificate.

Please refer to the attached certificate for the authorization number that was assigned to your project/site and the coverage effective date. Please use this number to reference this project/site for future communications with the Texas Commission on Environmental Quality (TCEQ).

Authorization under the Edwards Aquifer Protection Program is required before construction can begin where the site is located within the Edwards Aquifer Recharge Zone, Contributing Zone, or Contributing Zone within the Transition Zone.

See <https://www.tceq.texas.gov/permitting/eapp/viewer.html> for additional information.

It is the responsibility of the Operator to notify the TCEQ Stormwater Processing Center of any change in address supplied on the original Notice of Intent by submitting a Notice of Change.

A Notice of Termination must be submitted when permit coverage is no longer needed.

For questions related to the processing of your application you may contact the Stormwater Processing Center by email at SWPERMIT@tceq.texas.gov or by telephone at (512) 239-3700. If you have any technical questions regarding the general permit, you may contact the stormwater technical staff at (512) 239-4671 or by email at SWG@tceq.texas.gov. Also, you may obtain information on the stormwater web site at <https://www.tceq.texas.gov/permitting/stormwater>.

Sincerely,

A handwritten signature in black ink, appearing to read "Rob Sadler".

Robert Sadler, Deputy Director
Water Quality Division
Texas Commission on Environmental Quality

Texas Commission on Environmental Quality

Construction Notice of Intent

Site Information (Regulated Entity)

What is the name of the site to be authorized?	Espino Tract, 16 Inch Offsite Water Line
Does the site have a physical address?	No
Because there is no physical address, describe how to locate this site:	northeast of the intersection of Masterson Road and Hennersby Lane
City	San Antonio
State	TX
ZIP	78252
County	BEXAR
Latitude (N) (##.#####)	29.355531
Longitude (W) (-###.#####)	-98.764893
Primary SIC Code	6552
Secondary SIC Code	
Primary NAICS Code	
Secondary NAICS Code	

Regulated Entity Site Information

What is the Regulated Entity's Number (RN)?	
What is the name of the Regulated Entity (RE)?	Espino Tract, 16 Inch Offsite Water Line
Does the RE site have a physical address?	No
Because there is no physical address, describe how to locate this site:	northeast of the intersection of Masterson Road and Hennersby Lane
City	San Antonio
State	TX
ZIP	78252
County	BEXAR
Latitude (N) (##.#####)	29.355531
Longitude (W) (-###.#####)	-98.764893
Facility NAICS Code	
What is the primary business of this entity?	Land Developer

Customer (Applicant) Information

How is this applicant associated with this site?	Operator
What is the applicant's Customer Number (CN)?	CN603249053
Type of Customer	Corporation
Full legal name of the applicant:	
Legal Name	KB Home Lone Star Inc.
Texas SOS Filing Number	800836731
Federal Tax ID	
State Franchise Tax ID	12604657143
State Sales Tax ID	
Local Tax ID	
DUNS Number	

Number of Employees	501+
---------------------	------

Independently Owned and Operated?	Yes
-----------------------------------	-----

I certify that the full legal name of the entity applying for this permit has been provided and is legally authorized to do business in Texas.	Yes
--	-----

Responsible Authority Contact

Organization Name	KB Home Lone Star Inc.
-------------------	------------------------

Prefix	
--------	--

First	Ricardo
-------	---------

Middle	
--------	--

Last	Rodriguez
------	-----------

Suffix	
--------	--

Credentials	
-------------	--

Title	Sr. Construction Manager
-------	--------------------------

Responsible Authority Mailing Address

Enter new address or copy one from list:

Address Type	Domestic
--------------	----------

Mailing Address (include Suite or Bldg. here, if applicable)	4800 FREDERICKSBURG RD
--	------------------------

Routing (such as Mail Code, Dept., or Attn:)	
--	--

City	SAN ANTONIO
------	-------------

State	TX
-------	----

ZIP	78229
-----	-------

Phone (###-###-####)	2103012899
----------------------	------------

Extension	
-----------	--

Alternate Phone (###-###-####)	
--------------------------------	--

Fax (###-###-####)	
--------------------	--

E-mail	ryrodriguez@kbhome.com
--------	------------------------

Application Contact**Person TCEQ should contact for questions about this application:**

Same as another contact?	
--------------------------	--

Organization Name	Compliance Resources Inc
-------------------	--------------------------

Prefix	
--------	--

First	Amber
-------	-------

Middle	
--------	--

Last	Scheler
------	---------

Suffix	
--------	--

Credentials	
-------------	--

Title	SWP3 Manager
-------	--------------

Enter new address or copy one from list:

Mailing Address

Address Type	Domestic
--------------	----------

Mailing Address (include Suite or Bldg. here, if applicable)	PO BOX 2628
--	-------------

Routing (such as Mail Code, Dept., or Attn:)	
--	--

City	GEORGETOWN
------	------------

State	TX
-------	----

ZIP	78627
-----	-------

Phone (###-###-####)	5129307733
----------------------	------------

Extension	
-----------	--

Alternate Phone (###-###-####)

Fax (###-###-####)

E-mail

ascheler@complianceresourcesinc.com

CNOI General Characteristics

1 Is the project or site located on Indian Country Lands?	No
2 Is the project or site associated to a facility that is licensed for the storage of high-level radioactive waste by the United States Nuclear Regulatory Commission under 10 CFR Part 72?	No
3 Is your construction activity associated with an oil and gas exploration, production, processing, or treatment, or transmission facility?	No
4 Is the project or site associated to a quarrying facility that is located within either the John Graves Scenic Riverway or Coke Stevenson Scenic Riverway, as defined in 30 TAC 311.71?	No
5 What is the Primary Standard Industrial Classification (SIC) Code that best describes the construction activity being conducted at the site?	6552
6 If applicable, what is the Secondary SIC Code(s)?	
7 What is the total number of acres that the construction project or site will disturb under the control of the primary operator?	31.2
8 What is the construction project or site type?	Utility
9 Is the project part of a larger common plan of development or sale?	Yes
10 What is the estimated start date of the project?	05/26/2025
11 What is the estimated end date of the project?	05/26/2028
12 Will concrete truck washout be performed at the site?	Yes
13 What is the name of the first water body(s) to receive the stormwater runoff or potential runoff from the site?	Big Sous Creek, East Branch Big Sous Creek
14 What is the segment number(s) of the classified water body(s) that the discharge will eventually reach?	1903
15 Is the discharge into a Municipal Separate Storm Sewer System (MS4)?	Yes
15.1 What is the name of the MS4 Operator?	SAWS and Bexar County
16 Is the discharge or potential discharge within the Recharge Zone, Contributing Zone, or Contributing Zone within the Transition Zone of the Edwards Aquifer, as defined in 30 TAC Chapter 213?	No
17 I certify that a stormwater pollution prevention plan (SWP3) has been developed, will be implemented prior to construction, and to the best of my knowledge and belief is compliant with any applicable local sediment and erosion control plans, as required in the general permit TXR150000. Note: For multiple operators who prepare a shared SWP3, the confirmation of an operator may be limited to its obligations under the SWP3 provided all obligations are confirmed by at least one operator.	Yes
18 I certify that I have obtained a copy and understand the terms and conditions of the Construction General Permit (TXR150000).	Yes
19 I understand that a Notice of Termination (NOT) must be submitted when this authorization is no longer needed.	Yes

Certification

I certify that I am authorized under 30 Texas Administrative Code Subchapter 305.44 to sign this document and can provide documentation in proof of such authorization upon request.

I certify under penalty of law that this document and all attachments were prepared under my direction or supervision in accordance with a system designed to assure that qualified personnel properly gather and evaluate the information submitted. Based on my inquiry of the person or persons who manage the system, or those persons directly responsible for gathering the information, the information submitted is, to the best of my knowledge and belief, true, accurate, and complete. I am aware

there are significant penalties for submitting false information, including the possibility of fine and imprisonment for knowing violations.

1. I am Ricardo Rodriguez JR, the owner of the STEERS account ER090382.
2. I have the authority to sign this data on behalf of the applicant named above.
3. I have personally examined the foregoing and am familiar with its content and the content of any attachments, and based upon my personal knowledge and/or inquiry of any individual responsible for information contained herein, that this information is true, accurate, and complete.
4. I further certify that I have not violated any term in my TCEQ STEERS participation agreement and that I have no reason to believe that the confidentiality or use of my password has been compromised at any time.
5. I understand that use of my password constitutes an electronic signature legally equivalent to my written signature.
6. I also understand that the attestations of fact contained herein pertain to the implementation, oversight and enforcement of a state and/or federal environmental program and must be true and complete to the best of my knowledge.
7. I am aware that criminal penalties may be imposed for statements or omissions that I know or have reason to believe are untrue or misleading.
8. I am knowingly and intentionally signing Construction Notice of Intent.
9. My signature indicates that I am in agreement with the information on this form, and authorize its submittal to the TCEQ.

OPERATOR Signature: Ricardo Rodriguez JR OPERATOR

Customer Number:	CN603249053
Legal Name:	KB Home Lone Star Inc.
Account Number:	ER090382
Signature IP Address:	165.225.222.189
Signature Date:	2025-06-02
Signature Hash:	A1337D73AB47E800ADC3DDF75F56A112606FEEC40A724F3A98333298ABFDEEC7
Form Hash Code at time of Signature:	AAB2ADB8A15EEF0DD3389B0D7FDED2CDE0681B6B2EF8080CC5CD9C9D2B58FCE7

Fee Payment

Transaction by:	The application fee payment transaction was made by ER090382/Ricardo Rodriguez JR
Paid by:	The application fee was paid by RICARDO RODRIGUEZ
Fee Amount:	\$225.00
Paid Date:	The application fee was paid on 2025-06-02
Transaction/Voucher number:	The transaction number is 582EA000670547 and the voucher number is 769095

Submission

Reference Number:	The application reference number is 788605
Submitted by:	The application was submitted by ER090382/Ricardo Rodriguez JR
Submitted Timestamp:	The application was submitted on 2025-06-02 at 10:45:44 CDT
Submitted From:	The application was submitted from IP address 165.225.222.189
Confirmation Number:	The confirmation number is 656464
Steers Version:	The STEERS version is 6.91

Additional Information

Application Creator: This account was created by Amber Scheler



Documents Bot <documents@complianceresourcesinc.com>

TPDES MS4 Notification [KB Home Lone Star, Inc. - TXR1503UU] 6/4/2025

1 message

Documents at CRI <noreply@appsheet.com>

Wed, Jun 4, 2025 at 9:30 AM

Reply-To: documents@complianceresourcesinc.com

To: SWQ@bexar.org, zaid.subhi@bexar.org

Cc: dwright@pape-dawson.com, pwagnon@pape-dawson.com, vsanchez@pape-dawson.com



MS4 - TPDES Notification

To whom it may concern,

As required by the TCEQ General Permit Number TXR150000 for discharges of storm water runoff from construction sites, attached is a copy of the signed application for storm water discharges associated with construction activity.

**Operator - Authorization: KB Home Lone Star, Inc. -
TXR1503UU**

Project: Espino Tract (KB)

Application Type: Notice of Intent

Application Action: Initial Notice (16" Offsite WL)

Application Date: 6/2/2025

Thank you,

[Automated message]

Compliance Resources, Inc.

512-930-7733 Office

888-CRI-SW3P Toll Free

512-801-8144 Mobile

documents@complianceresourcesinc.com

www.complianceresourcesinc.com

MAILING ADDRESS: P.O. BOX 2628, GEORGETOWN, TX 78627

PHYSICAL ADDRESS: 1103 WILLIAMS DRIVE, BUILDING 2, GEORGETOWN, TX 78628

Providing **Accurate, Complete, and Timely** customer service that your company can rely on.

Please consider the environment before printing.

Powered by AppSheet



71dc084e.File.141717.pdf
386K



Documents Bot <documents@complianceresourcesinc.com>

TPDES MS4 Notification [KB Home Lone Star, Inc. - TXR1503UU] 6/4/2025

1 message

Documents at CRI <noreply@appsheet.com>

Wed, Jun 4, 2025 at 9:30 AM

Reply-To: documents@complianceresourcesinc.com

To: stormwaterconstruction@saws.org

Cc: dwright@pape-dawson.com, pwagnon@pape-dawson.com, vsanchez@pape-dawson.com



MS4 - TPDES Notification

To whom it may concern,

As required by the TCEQ General Permit Number TXR150000 for discharges of storm water runoff from construction sites, attached is a copy of the signed application for storm water discharges associated with construction activity.

**Operator - Authorization: KB Home Lone Star, Inc. -
TXR1503UU**

Project: Espino Tract (KB)

Application Type: Notice of Intent

Application Action: Initial Notice (16" Offsite WL)

Application Date: 6/2/2025

Thank you,

[Automated message]

Compliance Resources, Inc.

512-930-7733 Office

888-CRI-SW3P Toll Free

512-801-8144 Mobile

documents@complianceresourcesinc.com

www.complianceresourcesinc.com

MAILING ADDRESS: P.O. BOX 2628, GEORGETOWN, TX 78627

PHYSICAL ADDRESS: 1103 WILLIAMS DRIVE, BUILDING 2, GEORGETOWN, TX 78628

Providing **Accurate, Complete, and Timely** customer service that your company can rely on.

Please consider the environment before printing.



TEXAS COMMISSION ON ENVIRONMENTAL QUALITY
Texas Pollutant Discharge Elimination System
Stormwater Construction General Permit

The Notice of Change (NOC) submitted to update the Notice of Intent (NOI) for the facility listed below was received on July 8, 2025. The intent to discharge stormwater associated with construction activity under the terms and conditions imposed by the Texas Pollutant Discharge Elimination System (TPDES) stormwater Construction General Permit (CGP) TXR150000 is acknowledged. Your facility's unique TPDES CGP stormwater authorization number is:

TXR1503UU

Coverage Effective: June 02, 2025

The TCEQ's stormwater CGP requires certain stormwater pollution prevention and control measures, possible monitoring and reporting, and periodic inspections. Among the conditions and requirements of this permit, you must have prepared and implemented a stormwater pollution prevention plan (SWP3) that is tailored to your construction site. As a facility authorized to discharge under the stormwater CGP, all terms and conditions must be complied with to maintain coverage and avoid possible penalties.

Project/Site Information:

RN112223730
Espino Tract 16 Inch Offsite Water Line
Northeast of The Intersection of Masterson Road And Hennersby Lane
San Antonio, TX 78252
Bexar County

Operator:

CN603249053
Kb Home Lone Star Inc.
4800 Fredericksburg Rd
San Antonio, TX 78229

This CGP and all authorizations expire on March 5, 2028, unless otherwise amended. If you have any questions related to processing of your application, you may contact the Stormwater Processing Center by **email** at SWPERMIT@tceq.texas.gov or **by telephone** at (512) 239-3700. For technical issues, you may contact the stormwater technical staff by **email** at SWGPA@tceq.texas.gov or **by telephone** at (512) 239-4671. Also, you may obtain information on the TCEQ web site at <https://www.tceq.texas.gov/goto/wq-dpa>. A copy of this document should be kept with your SWP3.

A handwritten signature in black ink, appearing to read "K. Keel".

Issued Date: July 08, 2025

FOR THE COMMISSION

Texas Commission on Environmental Quality

Construction Notice of Change

TXR1503UU

Site Information (Regulated Entity)

What is the name of the site to be authorized?	ESPINO TRACT 16 INCH OFFSITE WATER LINE
Does the site have a physical address?	No
Because there is no physical address, describe how to locate this site:	NORTHEAST OF THE INTERSECTION OF MASTERSON ROAD AND HENNERSBY LANE
City	SAN ANTONIO
State	TX
ZIP	78252
County	BEXAR
Latitude (N) (##.#####)	29.355531
Longitude (W) (-###.#####)	-98.764893
Primary SIC Code	6552
Secondary SIC Code	
Primary NAICS Code	
Secondary NAICS Code	
Regulated Entity Site Information	
What is the Regulated Entity's Number (RN)?	RN112223730
What is the name of the Regulated Entity (RE)?	ESPINO TRACT 16 INCH OFFSITE WATER LINE
Does the RE site have a physical address?	No
Physical Address	
Because there is no physical address, describe how to locate this site:	NORTHEAST OF THE INTERSECTION OF MASTERSON ROAD AND HENNERSBY LANE
City	SAN ANTONIO
State	TX
ZIP	78252
County	BEXAR
Latitude (N) (##.#####)	29.355531
Longitude (W) (-###.#####)	-98.764893
Facility NAICS Code	
What is the primary business of this entity?	LAND DEVELOPER
Customer (Applicant) Information	
How is this applicant associated with this site?	Operator
What is the applicant's Customer Number (CN)?	CN603249053
Type of Customer	Corporation
Full legal name of the applicant:	
Legal Name	KB Home Lone Star Inc.
Texas SOS Filing Number	800836731
Federal Tax ID	

State Franchise Tax ID	12604657143
------------------------	-------------

State Sales Tax ID	
--------------------	--

Local Tax ID	
--------------	--

DUNS Number	
-------------	--

Number of Employees	501+
---------------------	------

Independently Owned and Operated?	Yes
-----------------------------------	-----

I certify that the full legal name of the entity applying for this permit has been provided and is legally authorized to do business in Texas.	Yes
--	-----

Responsible Authority Contact

Organization Name	KB Home Lone Star Inc.
-------------------	------------------------

Prefix	
--------	--

First	RICARDO
-------	---------

Middle	
--------	--

Last	RODRIGUEZ
------	-----------

Suffix	
--------	--

Credentials	
-------------	--

Title	SR. CONSTRUCTION MANAGER
-------	--------------------------

Responsible Authority Mailing Address

Enter new address or copy one from list:

Address Type	Domestic
--------------	----------

Mailing Address (include Suite or Bldg. here, if applicable)	4800 FREDERICKSBURG RD
--	------------------------

Routing (such as Mail Code, Dept., or Attn:)	
--	--

City	SAN ANTONIO
------	-------------

State	TX
-------	----

ZIP	78229
-----	-------

Phone (###-###-####)	2103012899
----------------------	------------

Extension	
-----------	--

Alternate Phone (###-###-####)	
--------------------------------	--

Fax (###-###-####)	
--------------------	--

E-mail	RYRODRIGUEZ@KBHOME.COM
--------	------------------------

Application Contact

Person TCEQ should contact for questions about this application:

Same as another contact?	
--------------------------	--

Organization Name	COMPLIANCE RESOURCES INC
-------------------	--------------------------

Prefix	
--------	--

First	AMBER
-------	-------

Middle	
--------	--

Last	SCHELER
------	---------

Suffix	
--------	--

Credentials	
-------------	--

Title	SWP3 MANAGER
-------	--------------

Enter new address or copy one from list:

Mailing Address

Address Type	Domestic
--------------	----------

Mailing Address (include Suite or Bldg. here, if applicable)	PO BOX 2628
--	-------------

Routing (such as Mail Code, Dept., or Attn:)	
--	--

City	GEORGETOWN
------	------------

State	TX
ZIP	78627
Phone (###-###-####)	5129307733
Extension	
Alternate Phone (###-###-####)	
Fax (###-###-####)	
E-mail	ASCHELER@COMPLIANCERESOURCESINC.COM

Notice of Change General Characteristics

1 What are you proposing to change from what was last provided for this permit?	Changes to General Characteristics
2 What is the Primary Standard Industrial Classification (SIC) Code that best describes the construction activity being conducted at the site?	6552
3 If applicable, what is the Secondary SIC Code(s)?	
4 What is the total number of acres that the construction project or site will disturb under the control of the primary operator?	29.28
5 Is the project site part of a larger common plan of development or sale?	Yes
6 What is the estimated start date of the project?	05/26/2025
7 What is the estimated end date of the project?	05/26/2028
8 What is the construction project or site type?	UTILITY
9 Will concrete truck washout be performed at the site?	Yes
10 What is the name of the first water body(s) to receive the stormwater runoff or potential runoff from the site?	BIG SOUS CREEK,EAST BRANCH BIG SOUS CREEK
11 What is the segment number(s) of the classified water body(s) that the discharge will eventually reach?	1903
12 Is the discharge into a Municipal Separate Storm Sewer System (MS4)?	Yes
12.1 What is the name of the MS4 Operator?	SAWS AND BEXAR COUNTY
13 Is the discharge or potential discharge within the Recharge Zone, Contributing Zone, or Contributing Zone within the Transition Zone of the Edwards Aquifer, as defined in 30 TAC Chapter 213?	No
14 I certify that a stormwater pollution prevention plan (SWP3) has been developed, will be implemented prior to construction, and to the best of my knowledge and belief is compliant with any applicable local sediment and erosion control plans, as required in the general permit TXR150000. Note: For multiple operators who prepare a shared SWP3, the confirmation of an operator may be limited to its obligations under the SWP3 provided all obligations are confirmed by at least one operator.	Yes

Certification

I certify that I am authorized under 30 Texas Administrative Code 305.44 to sign this document and can provide documentation in proof of such authorization upon request.

I certify under penalty of law that this document and all attachments were prepared under my direction or supervision in accordance with a system designed to assure that qualified personnel properly gather and evaluate the information submitted. Based on my inquiry of the person or persons who manage the system, or those persons directly responsible for gathering the information, the information submitted is, to the best of my knowledge and belief, true, accurate, and complete. I am aware there are significant penalties for submitting false information, including the possibility of fine and imprisonment for knowing violations.

1. I am Ricardo Rodriguez JR, the owner of the STEERS account ER090382.
2. I have the authority to sign this data on behalf of the applicant named above.
3. I have personally examined the foregoing and am familiar with its content and the content of any attachments, and based upon my personal knowledge and/or inquiry of any individual responsible for information contained herein, that this information is true, accurate, and complete.

4. I further certify that I have not violated any term in my TCEQ STEERS participation agreement and that I have no reason to believe that the confidentiality or use of my password has been compromised at any time.
5. I understand that use of my password constitutes an electronic signature legally equivalent to my written signature.
6. I also understand that the attestations of fact contained herein pertain to the implementation, oversight and enforcement of a state and/or federal environmental program and must be true and complete to the best of my knowledge.
7. I am aware that criminal penalties may be imposed for statements or omissions that I know or have reason to believe are untrue or misleading.
8. I am knowingly and intentionally signing Construction Notice of Change TXR1503UU.
9. My signature indicates that I am in agreement with the information on this form, and authorize its submittal to the TCEQ.

OPERATOR Signature: Ricardo Rodriguez JR OPERATOR

Customer Number:	CN603249053
Legal Name:	KB Home Lone Star Inc.
Account Number:	ER090382
Signature IP Address:	170.85.98.174
Signature Date:	2025-07-08
Signature Hash:	A1337D73AB47E800ADC3DDDF75F56A112606FEEC40A724F3A98333298ABFDDEEC7
Form Hash Code at time of Signature:	FCB934CC847EDDA874A4EB520538E9736E09788E81318F69E870015E6E5AFDED

Submission

Reference Number:	The application reference number is 799015
Submitted by:	The application was submitted by ER090382/Ricardo Rodriguez JR
Submitted Timestamp:	The application was submitted on 2025-07-08 at 17:02:46 CDT
Submitted From:	The application was submitted from IP address 170.85.98.174
Confirmation Number:	The confirmation number is 663414
Steers Version:	The STEERS version is 6.92
Permit Number:	The permit number is TXR1503UU

Additional Information

Application Creator: This account was created by Amber Scheler



Documents Bot <documents@complianceresourcesinc.com>

TPDES MS4 Notification [KB Home Lone Star, Inc. - TXR1503UU] 7/9/2025

1 message

Documents at CRI <noreply@appsheet.com>

Wed, Jul 9, 2025 at 9:15 AM

Reply-To: documents@complianceresourcesinc.com

To: SWQ@bexar.org, zaid.subhi@bexar.org

Cc: dwright@pape-dawson.com, pwagnon@pape-dawson.com, vsanchez@pape-dawson.com



MS4 - TPDES Notification

To whom it may concern,

As required by the TCEQ General Permit Number TXR150000 for discharges of storm water runoff from construction sites, attached is a copy of the signed application for storm water discharges associated with construction activity.

**Operator - Authorization: KB Home Lone Star, Inc. -
TXR1503UU**

Project: Espino Tract (KB)

Application Type: Notice of Change

Application Action: decrease acreage

Application Date: 7/8/2025

Thank you,

[Automated message]

Compliance Resources, Inc.

512-930-7733 Office

888-CRI-SW3P Toll Free

512-801-8144 Mobile

documents@complianceresourcesinc.com

www.complianceresourcesinc.com

MAILING ADDRESS: P.O. BOX 2628, GEORGETOWN, TX 78627

PHYSICAL ADDRESS: 1103 WILLIAMS DRIVE, BUILDING 2, GEORGETOWN, TX 78628

Providing **Accurate, Complete, and Timely** customer service that your company can rely on.

Please consider the environment before printing.

Powered by AppSheet



6e39ce38.File.140720.pdf

258K

Powered by AppSheet



71dc084e.File.141717.pdf
386K

Texas Commission on Environmental Quality

Delegation of Signatories - CGP

multiple

Section 1# Site Information

Site Info#: 1

Authorization Number, Site Name, Regulated Entity Number, Regulated Entity Name, Physical Location	TXR1549UO ESPINO TRACT UNIT 1 & 16-INCH OFFSITE WATER LINE RN112212147 ESPINO TRACT UNIT 1 & 16-INCH OFFSITE WATER LINE NORTHEAST OF THE INTERSECTION OF MASTERSON ROAD AND HENNERSBY LANE, SAN ANTONIO, TX, 78252
--	--

Customer (Applicant) Information

How is this applicant associated with this site?	Operator
What is the applicant's Customer Number (CN)?	CN603249053
Type of Customer	Corporation
Full legal name of the applicant:	
Legal Name	KB Home Lone Star Inc.
Texas SOS Filing Number	800836731
Federal Tax ID	
State Franchise Tax ID	12604657143
State Sales Tax ID	
Local Tax ID	
DUNS Number	
Number of Employees	501+
Independently Owned and Operated?	Yes

Section 1# Delegated Information

Delegation#: 1

1 Position	Project Manager
2 Name	
3 I certify that the person/title above is a duly authorized representative described in 30 TAC 305.128.	Yes

Delegation#: 2

1 Position	Construction Manager
2 Name	
3 I certify that the person/title above is a duly authorized representative described in 30 TAC 305.128.	Yes

Delegation#: 3

1 Position	Site Superintendent
2 Name	
3 I certify that the person/title above is a duly authorized representative described in 30 TAC 305.128.	Yes

Certification

1 I understand that this authorization does not extend to the signing of a Notice of Intent, Notice of Change, or Notice of Termination for obtaining coverage under a stormwater general permit. Yes

Delegation Application Contact

Person TCEQ should contact for questions about this application:

1 Organization Name	KB Home Lone Star Inc
2 Prefix	
3 First	Ricardo
4 Middle	
5 Last	Rodriguez
6 Suffix	
7 Credentials	
8 Title	Sr. Construction Manager
Mailing Address	
9 Address Type	Domestic
9.1 Mailing Address (include Suite or Bldg. here, if applicable)	4800 Fredericksburg Road
9.2 Routing (such as Mail Code, Dept., or Attn:)	
9.3 City	San Antonio
9.4 State	TX
9.5 ZIP	78229
10 Phone (###-###-####)	2103012899
11 Extension	
12 Alternate Phone (###-###-####)	
13 Fax (###-###-####)	
14 Email	

Certification

I certify under penalty of law that this document and all attachments were prepared under my direction or supervision in accordance with a system designed to assure that qualified personnel properly gather and evaluate the information submitted. Based on my inquiry of the person or persons who manage the system, or those persons directly responsible for gathering the information, the information submitted is, to the best of my knowledge and belief, true, accurate, and complete. I am aware there are significant penalties for submitting false information, including the possibility of fine and imprisonment for knowing violations.

I certify that I am authorized under 30 Texas Administrative Code 305.44 to sign this document and can provide documentation in proof of such authorization upon request.

1. I am Ricardo Rodriguez JR, the owner of the STEERS account ER090382.
2. I have the authority to sign this data on behalf of the applicant named above.
3. I have personally examined the foregoing and am familiar with its content and the content of any attachments, and based upon my personal knowledge and/or inquiry of any individual responsible for information contained herein, that this information is true, accurate, and complete.
4. I further certify that I have not violated any term in my TCEQ STEERS participation agreement and that I have no reason to believe that the confidentiality or use of my password has been compromised at any time.
5. I understand that use of my password constitutes an electronic signature legally equivalent to my written signature.
6. I also understand that the attestations of fact contained herein pertain to the implementation, oversight and enforcement of a state and/or federal environmental program and must be true and complete to the best of my knowledge.
7. I am aware that criminal penalties may be imposed for statements or omissions that I know or have reason to believe are untrue or misleading.
8. I am knowingly and intentionally signing Delegation of Signatories - CGP multiple.
9. My signature indicates that I am in agreement with the information on this form, and authorize its submittal to the TCEQ.

OPERATOR Signature: Ricardo Rodriguez JR OPERATOR

Customer Number:	CN603249053
Legal Name:	KB Home Lone Star Inc.
Account Number:	ER090382
Signature IP Address:	165.225.222.189
Signature Date:	2025-06-02
Signature Hash:	A1337D73AB47E800ADC3DDF75F56A112606FEEC40A724F3A98333298ABFDEEC7
Form Hash Code at time of Signature:	E3550CA424F87962004F078EA6991250A09866B0Aafb72f0a19193df11377fdf

Submission

Reference Number:	The application reference number is 786311
Submitted by:	The application was submitted by ER090382/Ricardo Rodriguez JR
Submitted Timestamp:	The application was submitted on 2025-06-02 at 10:40:21 CDT
Submitted From:	The application was submitted from IP address 165.225.222.189
Confirmation Number:	The confirmation number is 656460
Steers Version:	The STEERS version is 6.91

Additional Information

Application Creator: This account was created by Amber Scheler

Storm Water Pollution Prevention Plan
For Espino Tract, 16-Inch Offsite Water (Oversized)

SWPPP Certification - Authority Signature

“I certify under penalty of law that this document and all attachments were prepared under my direction or supervision in accordance with a system designed to assure that qualified personnel properly gathered and evaluated the information submitted. Based on my inquiry of the person or persons who manage the system, or those persons directly responsible for gathering the information, the information submitted is, to the best of my knowledge and belief, true, accurate, and complete. I am aware that there are significant penalties for submitting false information, including the possibility of fine and imprisonment for knowing violations.”

Authority Representative Name and Title:

Ricardo Rodriguez
Sr. Construction Manager
KB Home Lone Star, Inc.

Ricardo Rodriguez

6/2/25

Signature

Date



TCEQ Large Construction Site Notice

Primary Operator

Large construction sites disturb more than five acres or are part of a larger common plan of development that disturbs more than five acres. Primary operators of large construction sites will fill out this notice. Primary operators will then post this notice at the construction site in a location where it is safely and readily available for viewing by the general public and local, state, and federal authorities. Additional information about the TCEQ Construction Stormwater General Permit may be found on TCEQ's webpage on [Assistance Tools for Construction Stormwater General Permits](#).

Note: You must also develop a Stormwater Pollution Prevention Plan prior to the commencement of construction.

Site-Specific TPDES Authorization Number: TXR15Pending

Primary Operator Name: GENERAL CONTRACTOR TO BE DETERMINED

Contact Name and Phone Number:

Contact Name

Project Description:

Physical Location/Description: Espino Tract, 16-inch Offsite Water Line (KB) northeast of the intersection of Masterson Road and Hennersby Lane, San Antonio, TX 78252

Estimated Start Date: 12/15/2025

Projected End Date or Date Disturbed Soils Will Be Stabilized: 06/15/2026

Location of Stormwater Pollution Prevention Plan (SWP3):

Compliance Resources, Inc. 1103 Williams Drive, Bldg. 2 Georgetown, TX 78628 (Maintained Electronically)

Storm Water Pollution Prevention Plan
For Espino Tract, 16-Inch Offsite Water (Oversized)

SWPPP Certification - Authority Signature

“I certify under penalty of law that this document and all attachments were prepared under my direction or supervision in accordance with a system designed to assure that qualified personnel properly gathered and evaluated the information submitted. Based on my inquiry of the person or persons who manage the system, or those persons directly responsible for gathering the information, the information submitted is, to the best of my knowledge and belief, true, accurate, and complete. I am aware that there are significant penalties for submitting false information, including the possibility of fine and imprisonment for knowing violations.”

Authority Representative Name and Title:

Corporate Authority Name:

Corporate Title:

GENERAL CONTRACTOR TO BE DETERMINED

Signature

Date

Storm Water Pollution Prevention Plan
For Espino Tract, 16-inch Offsite Water Line (Oversized)

Appendix B - Edwards Aquifer Protection Plan

N/A

Storm Water Pollution Prevention Plan
For Espino Tract, 16-inch Offsite Water Line (Oversized)

Appendix C - Inspection Reports

Storm Water Pollution Prevention Plan
For Espino Tract, 16-inch Offsite Water Line (Oversized)

Appendix D - Site Maps

Storm Water Pollution Prevention Plan
For Espino Tract, 16-inch Offsite Water Line (Oversized)

Appendix E - Dewatering Evaluations

Storm Water Pollution Prevention Plan
For Espino Tract, 16-inch Offsite Water Line (Oversized)

Appendix F - Transfer of Day-to-Day Operational Control

The new primary operator must submit a Notice of Intent at least ten (10) days prior to the transfer of operational control.

Documentation of notifying the new primary operator of their authorization responsibility is located in this appendix.

Name of new primary operator assuming day-to-day operational control	Authorization Number	Operator Scope